



FLUIDS

# Connections for Fluid Applications

*The Optimum Choice for Performance, Convenience  
and Safety*



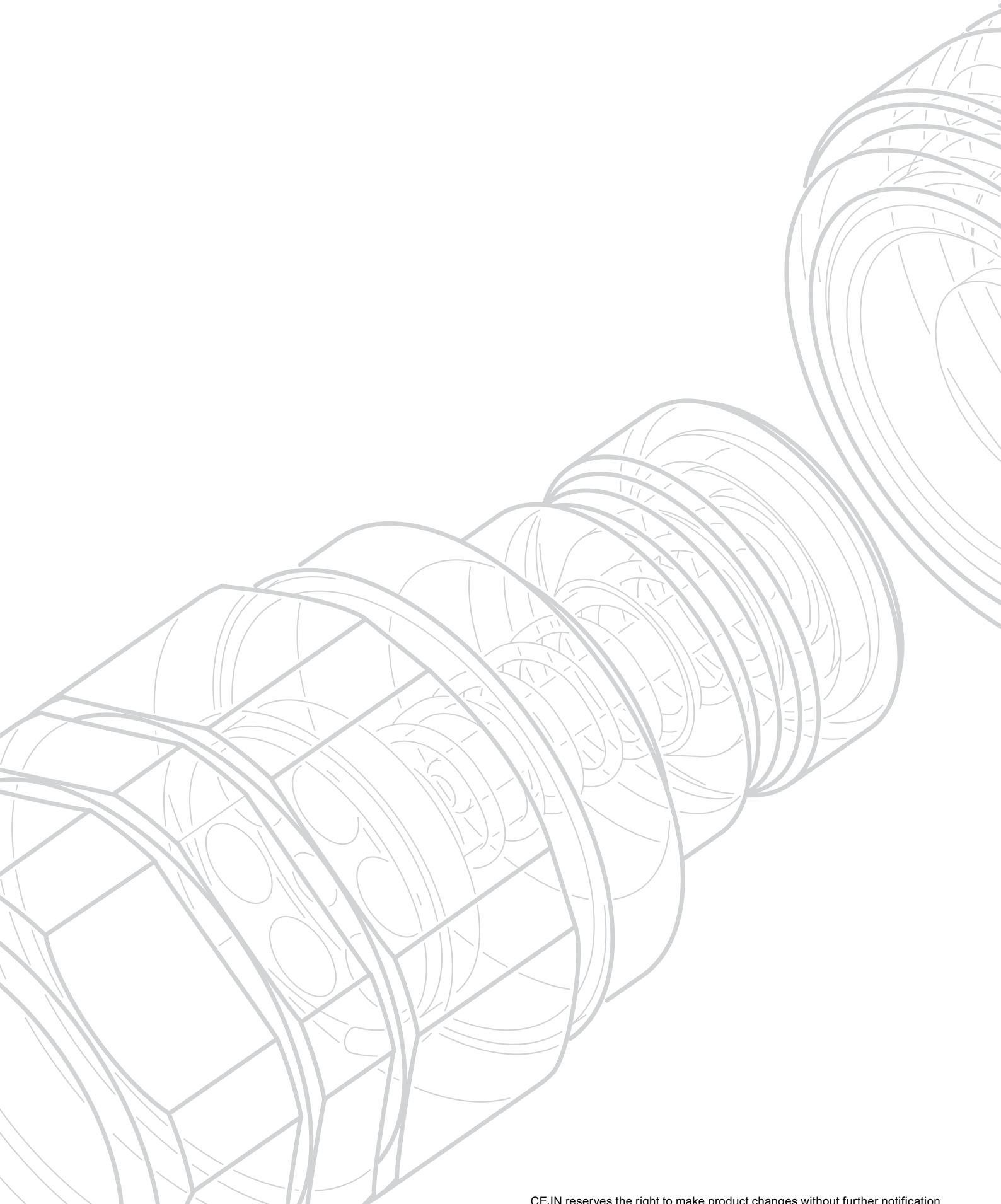

CEJN reserves the right to make product changes without further notification.

Reliable, High-Flow Couplings for a Wide Range of Fluid Applications Available in brass or stainless steel, valved or valveless – up to 200 bar (2900 PSI)

## Content



**05** CEJN – YOUR RELIABLE PARTNER FOR HIGH-QUALITY FLUID COUPLINGS

---

**07** OVERVIEW – CEJN FLUID COUPLINGS

---

**08** PRODUCT RANGE - CLASSIC RANGE

---

**22** PRODUCT RANGE - NON-DRIP RANGE

---

**24** COMPLEMENTARY PRODUCTS

---



**26** FACTS AND FIGURES





# CEJN – Your Reliable Partner for High-Quality Fluid Couplings



**CEJN Corporate Headquarter**  
CEJN AB  
Skövde, Sweden

**CEJN Sales Offices:**  
CEJN Norden AB  
Skövde, Sweden

CEJN Denmark Aps  
Esbjerg, Denmark

CEJN Product GmbH  
Troisdorf, Germany

CEJN France S.A.S  
Paris, France

CEJN AG  
Cham, Switzerland

CEJN Italy S.R.L.  
Milan, Italy

CEJN Ibérica S.L.  
Barcelona, Spain

CEJN UK Limited  
Herefordshire, United Kingdom

CEJN Industrial Corporation  
Chicago, USA

CEJN Mexico S.A de C.V  
Monterrey, Mexico

CEJN Do Brasil LTDA  
Curitiba, Brazil

CEJN Australia PTY Limited  
Sydney, Australia

CEJN Japan Corporation  
Tokyo, Japan

CEJN Products Far East PTE LTD.  
Singapore City, Singapore

CEJN Products India Pvt. Ltd.  
Bangalore, India

CEJN Products Far East CO, LTD.  
Seoul, Korea

CEJN Shanghai Fluid Systems CO LTD  
Shanghai, China

*The ability to quickly connect and disconnect fluid lines is the fundamental role of quick couplings in fluid transfer applications. Fluid couplings must also be leak free and withstand the media being transferred and the atmospheric and operating conditions to which they are subjected.*

CEJN's leadership in the design, development, and manufacture of fluid couplings is evident in its more than 45 years of successful sales performance in numerous markets, each with its own specific demands.

This leadership is the result of our steadfast commitment to taking every step possible to ensure CEJN fluid couplings are synonymous with high quality and superior performance characteristics.

CEJN's fluid coupling lineup includes over 14 different series of products in both valved and valveless designs for low- and medium-pressure applications.

Offering maximum working pressures up to 200 bar (2900 PSI), CEJN offers just the right coupling solution for virtually any fluid transfer application – from petrochemical, to pharmaceutical, to paint – in which lines need to be connected and disconnected easily, safely, and reliably.

Incorporating an innovative, aerodynamic valve design, all CEJN fluid couplings offer superior flow capacity with minimal pressure drop.

They are available in stainless steel, nickel-, chrome-, or non-plated brass, depending on the series, with seals in nitrile, viton®, or EPDM. Upon request, other coupling and seal material options are available to comply with specific performance objectives.

Because smooth fluid flow is a critical requirement in system operation, CEJN vigorously tests each coupling it produces. All fluid couplings undergo extensive functionality and quality testing to ensure defect-free performance where it is needed most – at the jobsite.

*When you need smooth fluid flow and smooth equipment operation, call on CEJN – your Quick Connect Specialist and reliable partner for high-quality fluid couplings.*



ISO 9001 certified since 1995.  
ISO 14001 certified since 2006.





# Overview

## CEJN Fluid Couplings

	Series	141	221	225	321	322	324	326	411	412	414	416	417	604	606	704	706	
<b>Flow l/min.</b>																		
0-5		•																
5-10				•														
10-20								•										
20-30			•					•										
30-50							•					•						
50-75							•				•							
75-100				•	•							•						
100-150											•			•	•			
150-200									•	•								
200-250													•	•	•			•
250-300																	•	
<b>Function</b>																		
Single shut-off		•	•		•	•		•	•	•		•		•	•	•	•	•
Double shut-off				•			•	•			•	•		•	•	•	•	•
Straight through					•					•			•					
<b>Sealing</b>																		
Nitrile		1	1	1	1	1	1	1	1	1	1	1	1	1	2	1	2	
Viton®		2	2	2	2	2	2	1	2	2	2	1		2	1	2	1	
EP		2	2	2	2	2	2	2	2	2	2	2		2	2	2	2	
Kalrez®											2	2		2	2	2	2	
<b>Material</b>																		
Brass		•	•	•	•	•	•		•	•	•		•	•			•	
Stainless Steel AISI 316								•				•			•		•	
<b>Style</b>																		
Push-to-connect		•	•	•	•	•	•	•	•	•	•	•		•	•	•	•	•
Two-hand operation													•					
<b>Dust Caps</b>																		
Included							•	•			•	•		•	•	•	•	•
As accessory					•	•			•	•								
<b>Working Pressure</b>																		
8																		
10		•																
20													•					
35			•	•	•		•		•		•	•		•	•	•	•	•
70								•										
200						•				•								
<b>Vacuum use</b>																		
Yes		•	•	•							•	•	•	•	•	•	•	•
No					•	•	•	•	•	•								
	Series	141	221	225	321	322	324	326	411	412	414	416	417	604	606	704	706	

1 = as standard, 2 = on request



# Series 141

10 bar (145 PSI) – 3.5 l/min (0.8 GPM UK)



Series 141 miniature couplings are specially designed for dental and medical equipment applications. Among the smallest couplings available today, Series 141 features valved couplings and valveless nipples that are easily connected with one hand. Viton® and EPDM seals are available on request.

### Technical Data

Material: Chrome-plated brass  
 Flow capacity at 4 bar pressure drop: 3.5 l/min (0.77 GPM UK)  
 Max. working pressure: 10 bar (145 PSI)  
 Min. burst pressure: 40 bar (580 PSI)  
 Temperature range: -30°C to +100°C (-22°F to +212°F)  
 Nominal flow diameter: 2.5 mm (3/32")  
 Kv (Cv): 0.10 (0.12)

		Part No.	Connection	Seals	Length	Dia.	Hex.
<b>Couplings (valved)</b>	Hose connections	10 141 1001	5.0 mm (3/16")	NBR	52.0	12.0	-
	Female thread	10 141 1201	G 1/8"	NBR	43.5	15.0	13
	Male thread	10 141 1251	G 1/8"	NBR	40.0	12.7	11
		10 141 1451	NPT 1/8"	NBR	35.0	12.7	11
<b>Nipples (valveless)</b>	Hose connection	10 141 5000	3.0 mm (1/8")	-	32.0	7.0	-
		10 141 5001	5.0 mm (3/16")	-	40.5	7.0	-
	Female thread	10 141 5201	G 1/8"	-	30.0	13.9	12
	Male thread	10 141 5451	NPT 1/8"	-	31.0	12.7	11

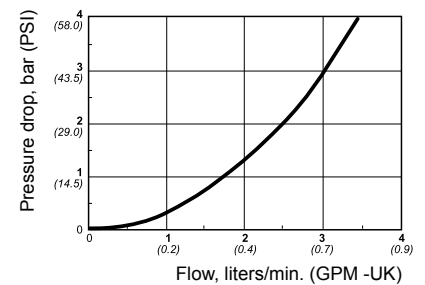

■ Single shut-off



Thread connections are listed according to ISO Standards. See Page 30 for additional information. All measurements are in mm. NBR=nitrile, FPM=Viton®. Check with an authorized CEJN distributor for availability and prices.

Information on CEJN's worldwide network of sales companies, agents, and distributors is available at [www.cejn.com](http://www.cejn.com).





# Series 220/221, 225

## 35 bar (508 PSI) – 26 l/min (5.72 GPM UK)

Requiring only one hand for operation, Series 220/221 and Series 225 couplings are suitable for a variety of fluid applications, such as water inlet and return for injection molding lines. Series 220/221 features valved couplings and valveless nipples. Series 225 features both valved couplings and valved nipples. Other sealing materials, such as viton® and EPDM, are available on request. Straight-through couplings are also available on request.

### Technical Data

Material: Series 220 coupling: Nickel-plated brass  
 Series 225 coupling: Chrome-plated brass  
 Nipple: Chrome-plated brass

Flow capacity at 4 bar pressure drop:  
 Series 221 valveless nipple: 26 l/min (5.72 GPM UK)  
 Series 225 valved nipple: 8 l/min (1.76 GPM UK)

Max. working pressure: 35 bar (508 PSI)  
 Min. burst pressure: 140 bar (2030 PSI)  
 Temperature range NBR: -30°C to +100°C (-22°F to +212°F)  
 Nominal flow diameter: Series 220 coupling: 5.0 mm (3/16")  
 Series 225 coupling: 3.0 mm (1/8")  
 Kv (Cv): Series 220: 0.79 (0.92)  
 Series 225: 0.24 (0.28)

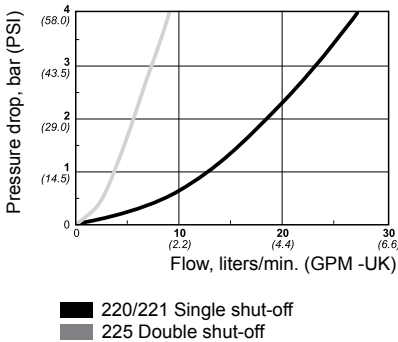

	Part No.	Connection	Seals	Length	Dia.	Hex.
<b>Couplings (valved)</b>	Hose connection					
	10 220 1001	5.0 mm (3/16")	NBR	47.4	19.6	17
	10 220 1002	6.3 mm (1/4")	NBR	47.4	19.6	17
	10 220 1003	8.0 mm (5/16")	NBR	50.4	19.6	17
	10 220 1004	10.0 mm (3/8")	NBR	50.4	19.6	17
	Male thread					
	10 220 1151	R 1/8"	NBR	39.4	19.6	17
	10 220 1152	R 1/4"	NBR	42.9	19.6	17
	10 220 1154	R 3/8"	NBR	41.4	19.6	17
	10 220 1451	NPT 1/8"	NBR	37.9	19.6	17
	10 220 1452	NPT 1/4"	NBR	42.4	19.6	17
	Female thread					
	10 220 1201	G 1/8"	NBR	38.9	19.6	17
	10 220 1202	G 1/4"	NBR	42.9	19.6	17
	10 220 1204	G 3/8"	NBR	44.4	23.1	20
10 220 1402	NPT 1/4"	NBR	42.9	19.6	17	
10 225 1202	G 1/4"	NBR	42.9	19.6	17	
<b>Nipples (valveless)</b>	Hose connection					
	10 221 5009*	5.0 mm (3/16")	-	36.0	11.0	-
	10 221 5002	6.3 mm (1/4")	-	36.0	11.0	-
	Male thread					
	10 221 5152	R 1/4"	-	33.0	16.2	14
	10 221 5251	G 1/8"	-	26.5	12.7	11
	10 221 5452	NPT 1/4"	-	33.0	16.2	14
	Female thread					
	10 221 5201	G 1/8"	-	26.5	15.0	13
	10 221 5202	G 1/4"	-	31.0	19.6	17
	Female thread (valved)					
	10 225 6202**	G 1/4"	NBR	31.0	19.6	17



\*\* Valved nipples in Series 225 can only be used with Series 225 couplings.

Thread connections are listed according to ISO Standards. See Page 30 for additional information. All measurements are in mm. NBR=nitrile, FPM=Viton®. Check with an authorized CEJN distributor for availability and prices.

# Series 321

## 35 bar (508 PSI) – 78 l/min (17.1 GPM UK)



Featuring valved couplings and valveless nipples, Series 321 has superior flow capacity. Series 321 is suitable for a variety of fluid applications, such as water inlet and return for injection molding lines. A large range of connections is available in the series that requires only one hand for operation. Other sealing materials, such as viton® and EPDM, are available on request.

### Technical Data

Material:	Nickel-plated brass
Flow capacity at 4 bar pressure drop:	78 l/min (17.16 GPM UK)
Max. working pressure:	35 bar (508 PSI)
Min. burst pressure:	140 bar (2030 PSI)
Temperature range NBR:	-20°C to +100°C (-4°F to +212°F)
Nominal flow diameter:	7.4 mm (9/32")
Kv (Cv):	2.34 (2.72)

	Part No.	Connection	Seals	Length	Dia.	Hex.
Couplings (valved)	Hose connection					
	10 321 1002	6.3 mm (1/4")	NBR	67.0	23.4	19
	10 321 1003	8.0 mm (5/16")	NBR	69.5	23.4	19
	10 321 1004	10.0 mm (3/8")	NBR	70.0	23.4	19
	10 321 1005	13.0 mm (1/2")	NBR	68.0	23.4	19
	Stream-Line connection					
	10 321 1062	8x12 mm	NBR	68.0	23.4	20/19
	10 321 1066	11x16 mm	NBR	68.0	27.7	24/24
	Male thread					
	10 321 1152	R 1/4"	NBR	63.0	23.4	20
	10 321 1154	R 3/8"	NBR	61.0	23.4	20
	10 321 1155	R 1/2"	NBR	55.5	25.4	22
	10 321 1254	G 3/8"	NBR	56.5	23.4	20
10 321 1452	NPT 1/4"	NBR	62.0	23.4	20	
Female thread						
10 321 1202	G 1/4"	NBR	60.0	23.4	20	
10 321 1204	G 3/8"	NBR	60.0	23.4	20	
10 321 1205	G 1/2"	NBR	59.5	28.9	25	
10 321 1402	NPT 1/4"	NBR	59.0	23.4	20	
Nipples (valveless)	Hose connection					
	10 321 5003	8.0 mm (5/16")	-	44.5	13.0	-
	10 321 5004	10.0 mm (3/8")	-	44.5	14.0	-
	10 321 5005	13.0 mm (1/2")	-	44.5	17.0	-
	Stream-Line Connection					
	10 321 5062	8x12 mm	-	46.3	21.9	19
	10 321 5066	11x16 mm	-	53.3	27.7	24
	Male thread					
	10 321 5151	R 1/8"	-	35.0	15.0	13
	10 321 5152	R 1/4"	-	38.5	16.2	14
	10 321 5154	R 3/8"	-	40.5	19.6	17
	10 321 5155	R 1/2"	-	47.0	25.4	22
	10 321 5452	NPT 1/4"	-	37.5	16.2	14
Female thread						
10 321 5202	G 1/4"	-	36.0	19.6	17	
10 321 5204	G 3/8"	-	37.5	21.3	20	

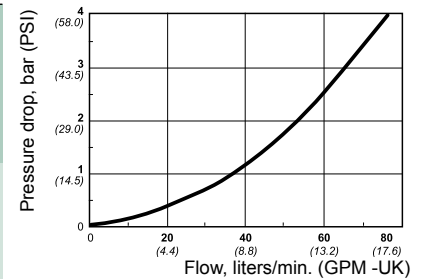

Thread connections are listed according to ISO Standards. See Page 30 for additional information. All measurements are in mm. NBR=nitrile, FPM=Viton®. Check with an authorized CEJN distributor for availability and prices.



# Series 321 Long

## 35 bar (508 PSI) – 78 l/min (17.1 GPM UK)

Series 321 with a long locking sleeve is specially designed for applications with built-in nipples, such as water inlet and return for injection molding lines (see picture). Featuring valved couplings and valveless nipples, this version has the same features as standard Series 321 couplings, including superior flow capacity. Other connections and sealing material are available on request.

### Technical Data

Material: Nickel-plated brass  
 Flow capacity at 4 bar pressure drop: 78 l/min (17.1 GPM UK)  
 Max. working pressure: 35 bar (508 PSI)  
 Min. burst pressure: 140 bar (2030 PSI)  
 Temperature range FPM: -15°C to +100°C (+5°F to +212°F)  
 Nominal flow diameter: 7.4 mm (9/32")  
 Kv (Cv): 2.34 (2.72)

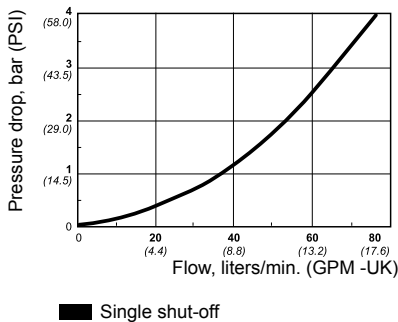

	Part No.	Connection	Seals	Length	Dia.	Hex.
Couplings (valved)	10 321 1044	8.0 mm (5/16")	FPM	67.5	23.4	19
	10 321 1045	13.0 mm (1/2")	FPM	65.5	23.4	19
Male thread	10 321 1294	G 3/8"	FPM	54.0	23.4	20
Female thread	10 321 1244	G 3/8"	FPM	57.5	23.4	20



Thread connections are listed according to ISO Standards. See Page 30 for additional information. All measurements are in mm. NBR=nitrile, FPM=Viton®. Check with an authorized CEJN distributor for availability and prices.



# Series 322

200 bar (2900 PSI) - 90 l/min (19.8 GPM UK)



Series 322 offers a high working pressure rating and high-flow capacity, making it ideal for high-pressure water applications, such as high-pressure cleaning lines. Available with valved or valveless couplings, the series requires only one hand for operation – just one of the reasons why this original CEJN series continues to be requested. Other connections and sealing materials are available on request.

### Technical Data

Material: Coupling  
Nipple

Brass/steel, nickle-plated  
Hardened steel, chemical nickel-plated/zinc-plated

Flow capacity at

4 bar pressure drop:

90 l/min (19.8 GPM UK)

Max. working pressure:

200 bar (2900 PSI)

Min. burst pressure:

600 bar (8700 PSI)

Temperature range NBR:

-30°C to +100°C (-22°F to +212°F)

Nominal flow diameter:

7.4 mm (9/32")

Kv (Cv):

2.70 (3.14)

	Part No.	Connection	Seals	Length	Dia.	Hex.	
Couplings	Male thread (valveless)	10 322 0252	G 1/4"	NBR	46.7	23.4	20
	(* with 60° sealing cone ** ratchet sleeve in steel)	10 322 0254 *	G 3/8"	NBR	48.2	23.4	20
		10 322 0255 *	G 1/2"	NBR	50.2	25.4	22
		10 322 0297 **	G 3/8"	FPM	48.2	23.4	20
	Male thread (valved)	10 322 1252	G 1/4"	FPM	55.3	23.4	20
	Female thread (valved)	10 322 1202	G 1/4"	NBR	56.8	23.4	20
		10 322 1204	G 3/8"	NBR	56.8	25.4	22
		10 322 1404	NPT 3/8"	NBR	55.8	25.4	22
	Female thread (valveless)	10 322 0202	G 1/4"	NBR	48.7	23.4	20
		10 322 0212	G 1/4"	FPM	48.7	23.4	20
10 322 0204		G 3/8"	NBR	49.7	25.4	22	
10 322 0214		G 3/8"	FPM	49.7	25.4	22	
10 322 0402		NPT 1/4"	NBR	55.7	23.4	20	
Nipples (valveless)	Male thread (Steel – hardened and yellow zinc-plated)	10 322 5162	R 1/4"	-	38.5	16.2	14
		10 322 5164	R 3/8"	-	40.5	19.6	17
	Male thread (Steel – hardened and chemical nickel-plated * with 60° sealing cone)	10 322 5252	G 1/4"	-	35.5	16.2	14
		10 322 5264 *	G 3/8"	-	37.5	19.6	17
	Female thread (Steel – hardened and yellow zinc-plated)	10 322 5212	G 1/4"	-	36.0	19.6	17
		10 322 5214	G 3/8"	-	37.5	23.1	20
	Female thread (Steel – hardened and chemical nickel-plated)	10 322 5202	G 1/4"	-	36.5	19.6	17
		10 322 5204	G 3/8"	-	38.0	23.1	20

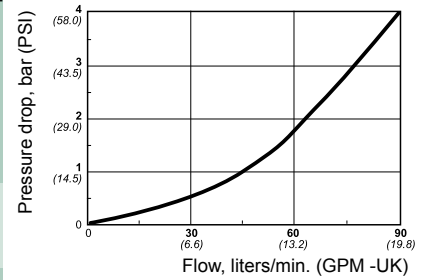

■ Single shut-off



Thread connections are listed according to ISO Standards. See Page 30 for additional information. All measurements are in mm. NBR=nitrile, FPM=Viton®. Check with an authorized CEJN distributor for availability and prices.

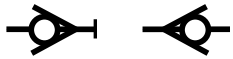

# Series 324

35 bar (508 PSI) - 42 l/min (9.2 GPM UK)

Series 324 offers a two-way shutoff and is connectable with the valveless nipple in Series 321. Designed with small external dimensions, it is suitable for a variety of fluid applications, such as water inlet and return for injection molding lines. Only one hand is required to connect this original CEJN product offering. Dust caps are included. Other sealing materials and connections are available on request.



## Technical Data

Material: Nickel-plated brass  
 Flow capacity at 4 bar pressure drop:  
 Series 324 nipple: 42 l/min (9.2 GPM UK)  
 Series 321 nipple: 53 l/min (11.6 GPM UK)  
 Max. working pressure: 35 bar (508 PSI)  
 Min. burst pressure: 140 bar (2030 PSI)  
 Temperature range NBR: -30°C to +100°C (-22°F to +212°F)  
 Nominal flow diameter: 6.2 mm (1/4")  
 Kv (Cv): 324 nipple 1.26 (1.46)  
 321 nipple 1.59 (1.85)

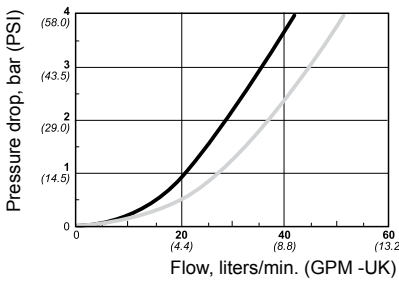

Series 324 nipple  
 Series 321 nipple



	Part No.	Connection	Seals	Length	Dia.	Hex.
<b>Couplings (valved)</b>	Hose connection					
	10 324 1002	6.0 mm (1/4")	NBR	66.3	23.4	20
	10 324 1003	8.0 mm (5/16")	NBR	68.3	23.4	20
	10 324 1004	10.0 mm (3/8")	NBR	67.3	23.4	20
	10 324 1005	13.0 mm (1/2")	NBR	66.3	23.4	20
<b>Couplings (valved)</b>	Male thread					
	10 324 1152	R 1/4"	NBR	59.3	23.4	20
	10 324 1154	R 3/8"	NBR	58.3	23.4	20
	10 324 1155	R 1/2"	NBR	51.8	25.4	22
	Female thread					
	10 324 1202	G 1/4"	NBR	56.3	23.4	20
	10 324 1204	G 3/8"	NBR	56.3	25.4	22
	10 324 1205	G 1/2"	NBR	60.3	28.9	25
	10 324 1212	G 1/4"	FPM	56.3	23.4	20
	10 324 1222	G 1/4"	EPDM	56.3	23.4	20
	10 324 1402	NPT 1/4"	NBR	56.3	23.4	20
<b>Nipples (valved)</b>	Female thread					
	10 324 6202	G 1/4"	NBR	52.1	23.1	20
	10 324 6212	G 1/4"	FPM	52.1	23.1	20
	10 324 6222	G 1/4"	EPDM	52.1	23.1	20
	10 324 6402	NPT 1/4"	NBR	52.1	23.1	20

Thread connections are listed according to ISO Standards. See Page 30 for additional information. All measurements are in mm. NBR=nitrile, FPM=Viton®. Check with an authorized CEJN distributor for availability and prices.

# Series 326

70 bar (1015 PSI) - 18 l/min (3.9 GPM UK)



Compatible with aggressive medias, Series 326 stands up to food, offshore, and steam applications. One- and two-way shut-off styles are included in the series that requires only one hand for operation. Dust caps are included as standard. EPDM seals are available on request.

### Technical Data

Material: Stainless steel, AISI 316  
 Flow capacity at 4 bar pressure drop:  
 Valved nipple: 18 l/min (3.96 GPM UK)  
 Valveless nipple: 28 l/min (6.16 GPM UK)  
 Max. working pressure: 70 bar (1015 PSI)  
 Min. burst pressure: 280 bar (4060 PSI)  
 Temperature range FPM: -15°C to +100°C (+5°F to +212°F)  
 Nominal flow diameter: 6.2 mm (1/4")  
 Kv (Cv): valved 0.54 (0.63)  
 valveless 0.84 (0.98)

	Part No.	Connection	Seals	Length	Dia.	Hex.	
<b>Couplings (valved)</b>	Female thread	10 326 1202	G 1/4"	NBR	51.3	24.3	21
	(* 9 mm)	10 326 1204	G 3/8" *	NBR	54.8	25.4	22
		10 326 1212	G 1/4"	FPM	51.3	24.3	21
		10 326 1214	G 3/8" *	FPM	54.8	25.4	22
<b>Nipples (valved)</b>	Female thread	10 326 6202	G 1/4"	NBR	52.1	22.0	19
		10 326 6204	G 3/8"	NBR	54.1	25.4	22
		10 326 6212	G 1/4"	FPM	52.1	22.0	19
		10 326 6214	G 3/8"	FPM	54.1	25.4	22
<b>Nipples (valveless)</b>	Female thread	10 326 5232	G 1/4"	-	37.5	19.6	17

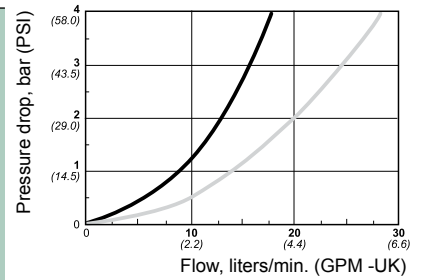

Double shut-off  
 Single shut-off



Thread connections are listed according to ISO Standards. See Page 30 for additional information. All measurements are in mm. NBR=nitrile, FPM=Viton®. Check with an authorized CEJN distributor for availability and prices.



CEJN uses only the finest raw materials to produce its high-quality products.



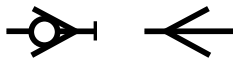

# Series 411

## 35 bar (508 PSI) - 156 l/min (34.3 GPM UK)

Series 411 features valved couplings and valveless nipples. Requiring only one hand for operation, the series is suitable for a variety of fluid applications, such as water inlet and return for injection molding lines.

# 411

### Technical Data

Material: Coupling- Nickel-plated brass  
Nipple- Chrome-plated brass

Flow capacity at 4 bar pressure drop: 156 l/min (34.32 GPM UK)  
Max. working pressure: 35 bar (508 PSI)  
Min. burst pressure: 140 bar (2030 PSI)  
Temperature range NBR: -30°C to +100°C (-22°F to +212°F)  
Nominal flow diameter: 10.4 mm (13/32")  
Kv (Cv): 4.68 (5.44)

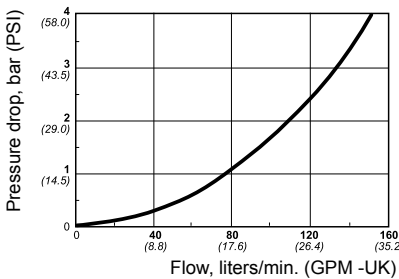

■ Single shut-off



	Part No.	Connection	Seals	Length	Dia.	Hex.
Couplings (valved)	Hose connection					
	10 411 1003	8.0 mm (5/16")	NBR	73.8	27.7	24
	10 411 1004	10.0 mm (3/8")	NBR	72.8	27.7	24
	10 411 1005	13.0 mm (1/2")	NBR	71.3	27.7	24
	10 411 1006	16.0 mm (5/8")	NBR	72.3	27.7	24
	10 411 1007	19.0 mm (3/4")	NBR	70.3	27.7	24
	Stream-Line Connection					
	10 411 1066	11x16 mm	NBR	78.6	27.7	24
	Male thread					
	10 411 1154	R 3/8"	NBR	63.8	27.7	24
10 411 1155	R 1/2"	NBR	66.3	27.7	24	
10 411 1157	R 3/4"	NBR	59.8	31.2	27	
Female thread						
10 411 1204	G 3/8"	NBR	58.3	27.7	24	
10 411 1205	G 1/2"	NBR	63.3	28.9	25	
10 411 1207	G 3/4"	NBR	60.3	37.0	32	
Nipples (valveless)	Hose connection					
	10 411 5004	10.0 mm (3/8")	-	46.5	17.0	-
	10 411 5005	13.0 mm (1/2")	-	46.0	17.0	-
	10 411 5006	16.0 mm (5/8")	-	48.5	21.0	-
	10 411 5007	19.0 mm (3/4")	-	49.0	25.0	-
	Stream-Line Connection					
	10 411 5066	11x16 mm	-	540.0	27.7	24
	Male thread					
	10 411 5255	G 1/2"	-	37.0	25.4	22
	10 411 5257	G 3/4"	-	39.5	31.2	27
Female thread						
10 411 5204	G 3/8"	-	34.5	24.2	21	
10 411 5205	G 1/2"	-	34.5	27.7	24	
10 411 5207	G 3/4"	-	35.0	34.6	30	

Thread connections are listed according to ISO Standards. See Page 30 for additional information. All measurements are in mm. NBR=nitril,FPM=Viton®. Check with an authorized CEJN distributor for availability and prices.

# Series 412

200 bar (2900 PSI) - 167 l/min (36.7 GPM UK)



The 200 bar working pressure of Series 412 makes this product line suitable for high-pressure water applications and high-pressure cleaning. Included in the series are valved and valveless couplings and valveless nipples. Only one hand is required for operation. Other sealing materials are available on request.

## Technical Data

Material: Coupling–Nickle-plated brass/steel  
Nipple–Hardened steel, chemical nickel-plated/zinc-plated

Flow capacity at 4 bar pressure drop: 167 l/min (36.74 GPM UK)

Max. working pressure: 200 bar (2900 PSI)

Min. burst pressure: 600 bar (8700 PSI)

Temperature range NBR: -30°C to +100°C (-22°F to +212°F)

Nominal flow diameter: 10.4 mm (13/32")

Kv (Cv): 5.01 (5.83)

	Part No.	Connection	Seals	Length	Dia.	Hex.
Couplings	Male thread (valveless)	10 412 0255 *	G 1/2"	NBR	50.7	27.7 24
	* with 60° sealing cone	10 412 0455	NPT 1/2"	NBR	65.3	27.7 24
	Female thread (valved)	10 412 1205	G 1/2"	NBR	63.3	28.9 25
	Female thread (valveless)	10 412 0205	G 1/2"	NBR	63.3	28.9 25
	10 412 0405	NPT 1/2"	NBR	63.3	28.9 25	
Nipples (valveless)	Male thread (Steel – hardened and chemical nickel-plated)	10 412 5265 *	G 1/2"	-	42.3	25.4 22
	* with 60° sealing cone					
	Female thread (Steel – hardened and chemical nickel-plated)	10 412 5205	G 1/2"	-	44.0	31.2 27
	Male thread (Steel – hardened and zinc-plated)	10 410 5154	R 3/8"	-	42.5	19.6 17
	10 410 5155	R 1/2"	-	48.0	25.4 22	
Female thread (Steel – hardened and zinc-plated)	10 410 5204	G 3/8"	-	39.0	23.1 20	
	10 410 5205	G 1/2"	-	44.0	31.2 27	

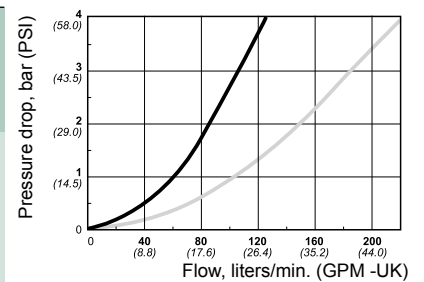

■ Single shut-off



Thread connections are listed according to ISO Standards. See Page 30 for additional information. All measurements are in mm. NBR = nitrile, FPM = Viton®. Check with an authorized CEJN distributor for availability and prices.

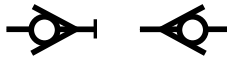

# Series 414

## 35 bar (508 PSI) - 71 l/min (15.6 GPM UK)

Series 414 includes a two-way shutoff and is connectable with Series 411 valveless nipples. Requiring only one hand for operation, Series 414 couplings are suitable for a variety of fluid applications, such as water inlet and return for injection molding lines. Dust caps are included as standard. Viton® and EPDM sealings are available on request.



### Technical Data

Material: Chrome-plated brass  
 Flow capacity at 4 bar pressure drop:  
 Series 414 nipple: 71 l/min (15.6 GPM UK)  
 Series 411 nipple: 104 l/min (22.9 GPM UK)  
 Max. working pressure: 35 bar (508 PSI)  
 Min. burst pressure: 140 bar (2030 PSI)  
 Temperature range NBR: -30°C to +100°C (-22°F to +212°F)  
 Nominal flow diameter: 8.9 mm (11/32")  
 Kv (Cv): double valved  
     411 nipple 2.13 (2.48)  
     414 nipple 3.12 (3.63)

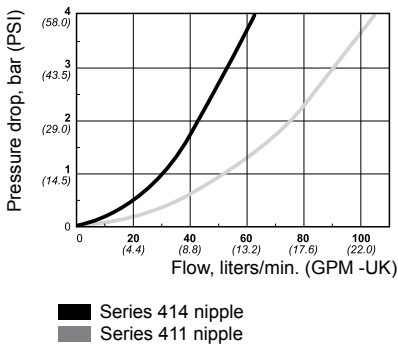

	Part No.	Connection	Seals	Length	Dia.	Hex.
Couplings (valved)	10 414 1004	Hose connection 10.0 mm (3/8")	NBR	72.8	27.7	24
	10 414 1005	13.0 mm (1/2")	NBR	71.3	27.7	24
	10 414 1006	16.0 mm (5/8")	NBR	71.3	27.7	24
	10 414 1007	19.0 mm (3/4")	NBR	70.3	27.7	24
Male thread	10 414 1154	R 3/8"	NBR	63.8	27.7	24
	10 414 1155	R 1/2"	NBR	66.3	27.7	24
	10 414 1157	R 3/4"	NBR	59.8	31.2	27
Female thread	10 414 1204	G 3/8"	NBR	58.3	27.7	24
	10 414 1205	G 1/2"	NBR	63.3	28.9	25
	10 414 1207	G 3/4"	NBR	60.3	37.0	32
	10 414 1405	NPT 1/2"	NBR	63.3	28.9	25
Nipples (valved)	10 414 6205	Female thread G 1/2"	NBR	59.4	31.2	27
	10 414 6405	NPT 1/2"	NBR	59.4	31.2	27



Thread connections are listed according to ISO Standards. See Page 30 for additional information. All measurements are in mm. NBR = nitrile, FPM = Viton®. Check with an authorized CEJN distributor for availability and prices.



# Series 416

## 35 bar (508 PSI)

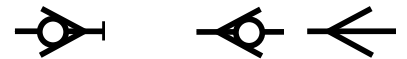

Compatible with aggressive medias, Series 416 stands up to food, offshore, and steam applications. One- and two-way shutoff styles are included in the series that requires only one hand for operation. Dust caps are included as standard. EPDM and Kalrez® seals are available on request.

### Technical Data

Material: Stainless steel, AISI 316  
 Flow capacity at 4 bar pressure drop:  
     Valved nipple: 45 l/min (9.9 GPM UK)  
     Valveless nipple: 85 l/min (18.7 GPM UK)  
 Max. working pressure: 35 bar (508 PSI)  
 Min. burst pressure: 140 bar (2030 PSI)  
 Temperature range FPM: -15°C to +205°C (+5°F to +401°F)  
 Nominal flow diameter: 8.9 mm (11/32")  
 Kv (Cv): 1.35 (1.57) valved, 2.55 (2.96) valveless nipple

		Part No.	Connection	Seals	Length	Dia.	Hex.
Couplings	Female thread (valved)	10 416 1205	G 1/2"	NBR	63.3	31.2	27
		10 416 1215	G 1/2"	FPM	63.3	31.2	27
Nipples	Female thread (valved)	10 416 6205	G 1/2"	NBR	60.5	31.2	27
		10 416 6215	G 1/2"	FPM	60.5	31.2	27
	Female thread (valveless)	10 416 5205	G 1/2"	-	45.0	31.2	27

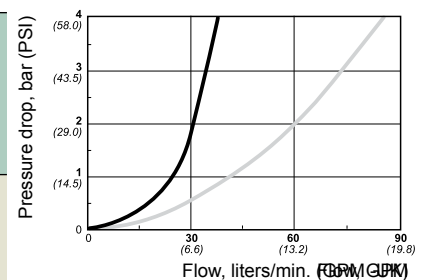

■ Double shut-off  
 ■ Single shut-off



Thread connections are listed according to ISO Standards. See Page 30 for additional information. All measurements are in mm. NBR = nitril, FPM = Viton®. Check with an authorized CEJN distributor for availability and prices.



# Series 417

20 bar (290 PSI) - 226 l/min (49.7 GPM UK)

The straight-through, valveless design of Series 417 couplings makes them ideal for garden and other low-pressure applications in which there is no need for valved-style couplings. Two hands are needed to connect Series 417 couplings, which are connectable to Series 411 nipples.

## Technical Data

Material: Chrome-plated brass  
 Flow capacity at 4 bar pressure drop: 226 l/min (49.72 GPM UK)  
 Max. working pressure: 20 bar (290 PSI)  
 Min. burst pressure: 80 bar (1160 PSI)  
 Temperature range: -30°C to +100°C (-22°F to +212°F)  
 Nominal flow diameter: 10.5 mm (13/32")  
 Kv (Cv): 6.78 (7.88)

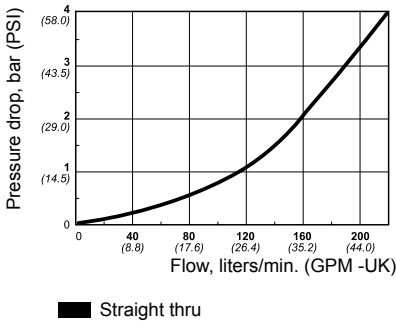

	Part No.	Connection	Seals	Length	Dia.	Hex.	
<b>Couplings (valveless)</b>	Hose connection	10 417 0005	13.0 mm (1/2")	NBR	45.0	24.0	
		10 417 0006	16.0 mm (5/8")	NBR	46.5	24.0	
		10 417 0007	19.0 mm (3/4")	NBR	47.0	24.0	
	Male thread	10 417 0255	G 1/2"	NBR	30.0	24.0	
		10 417 0257	G 3/4"	NBR	29.0	24.0	
	Female thread	10 417 0205	G 1/2"	NBR	32.5	27.7	24
10 417 0207		G 3/4"	NBR	34.0	32.0	30	
<b>Nipples (valveless)</b>	Hose connection	10 411 5004	10.0 mm (3/8")	-	46.5	17.0	
		10 411 5005	13.0 mm (1/2")	-	46.0	17.0	
		10 411 5006	16.0 mm (5/8")	-	48.5	21.0	
		10 411 5007	19.0 mm (3/4")	-	49.0	25.0	
	Male thread	10 411 5255	G 1/2"	-	37.0	25.4	22
		10 411 5257	G 3/4"	-	39.5	31.2	27
	Female thread	10 411 5204	G 3/8"	-	34.5	24.3	21
		10 411 5205	G 1/2"	-	34.5	27.7	24
		10 411 5207	G 3/4"	-	35.0	34.6	30
<b>Nipples (valved)</b>	Hose connection	10 411 7005	13.0 mm (1/2")	EPDM	64.0	23.0	
	Male thread	10 411 7255	G 1/2"	EPDM	37.0	25.4	22



Thread connections are listed according to ISO Standards. See Page 30 for additional information. All measurements are in mm. NBR = nitril, FPM = Viton®. Check with an authorized CEJN distributor for availability and prices.

# Series 604, 606

## 35 bar (508 PSI)



One- and two-way shutoff styles are included in Series 604 and Series 606 couplings that require only one hand for operation. Series 604 is suitable for a variety of fluid applications, such as water inlet and return. Series 606 stands up to food, offshore, and steam applications. Dust caps are included as standard.

### Technical Data Series 604

Material: Chrome-plated brass  
 Flow capacity at 4 bar pressure drop:  
     valved nipple: 140 l/min (30.8 GPM UK)  
     valveless nipple: 210 l/min (46.2 GPM UK)  
 Max. working pressure: 35 bar (508 PSI)  
 Min. burst pressure: 140 bar (2030 PSI)  
 Temperature range NBR: -30°C to +100°C (-22°F to +212°F)  
 Nominal flow diameter: 14.5 mm (9/16")  
 Kv (Cv): valved 4.20 (4.88)  
           valveless nipple 6.30 (7.33)

		Part No.	Connection	Seals	Length	Dia.	Hex.
<b>Couplings</b>	Female thread ( <i>valved</i> )	10 604 1201	G 3/4"	NBR	83.0	47.3	41
		10 604 1211	G 3/4"	FPM	83.0	47.3	41
		10 604 1401	NPT 3/4"	NBR	83.0	47.3	41
		10 604 1411	NPT 3/4"	FPM	83.0	47.3	41
		10 606 1211	G 3/4"	FPM	83.0	47.3	41
<b>Nipples</b>	Female thread ( <i>valved</i> )	10 604 6201	G 3/4"	NBR	81.5	41.6	36
		10 604 6211	G 3/4"	FPM	81.5	41.6	36
		10 604 6401	NPT 3/4"	NBR	81.5	41.6	36
		10 604 6411	NPT 3/4"	FPM	81.5	41.6	36
		10 606 6211	G 3/4"	FPM	81.5	41.6	36
	Female thread ( <i>valveless</i> )	10 604 5201	G 3/4"	-	81.5	41.6	36
		10 604 5401	NPT 3/4"	-	81.5	41.6	36
		10 606 5201	G 3/4"	-	81.5	41.6	36
		10 606 5401	NPT 3/4"	-	81.5	41.6	36

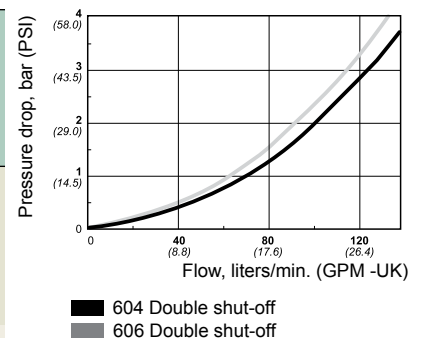

Thread connections are listed according to ISO Standards. See Page 30 for additional information. All measurements are in mm. NBR=nitrile, FPM=Viton®. Check with an authorized CEJN distributor for availability and prices.

### Technical Data Series 606

Material: Stainless steel, AISI 316  
 Flow capacity at 4 bar pressure drop:  
     valved nipple: 134 l/min (29.4 GPM UK)  
     valveless nipple: 207 l/min (45.5 GPM UK)  
 Max. working pressure: 35 bar (508 PSI)  
 Min. burst pressure: 140 bar (2030 PSI)  
 Temperature range: FPM -15°C to +205°C (+5°F to +401°F)  
 Nominal flow diameter: 14.5 mm (9/16")  
 Kv (Cv): valved 4.02 (4.67)  
           valveless nipple 6.21 (7.22)







# Series 704, 706

## 35 bar (508 PSI)

Requiring only one hand for operation, Series 704 and Series 706 couplings feature a two-way shutoff. A valveless nipple style is available upon request. Series 704 is suitable for water inlet and return for injection molding lines. Series 706 stands up to food, offshore, and steam applications. Dust caps are included as standard.



### Technical Data Series 704

Material: Chrome-plated brass  
 Flow capacity at 4 bar pressure drop: 271 l/min (59.62 GPM UK)  
 Max. working pressure: 35 bar (508 PSI)  
 Min. burst pressure: 140 bar (2030 PSI)  
 Temperature range NBR: -30°C to +100°C (-22°F to +212°F)  
 Nominal flow diameter: 19.0 mm (3/4")  
 Kv (Cv): 8.13 (9.45)

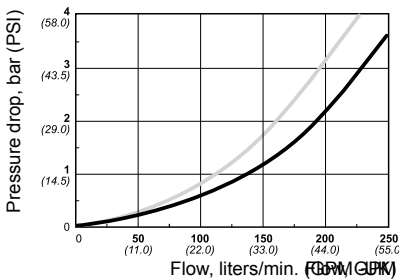

■ 704 Double shut-off  
 ■ 706 Double shut-off

	Part No.	Connection	Seals	Length	Dia.	Hex.	
<b>Couplings</b>	Female thread (valved)	10 704 1203	G 1"	NBR	94.0	53.1	46
		10 704 1213	G 1"	FPM	94.0	53.1	46
		10 704 1403	NPT 1"	NBR	94.0	53.1	46
		10 704 1413	NPT 1"	FPM	94.0	53.1	46
		10 706 1213	G 1"	FPM	94.0	53.0	46
<b>Nipples</b>	Female thread (valved)	10 704 6203	G 1"	NBR	91.5	53.1	46
		10 704 6213	G 1"	FPM	91.5	53.1	46
		10 704 6403	NPT 1"	NBR	91.5	53.1	46
		10 704 6413	NPT 1"	FPM	91.5	53.1	46
		10 706 6213	G 1"	FPM	91.5	53.1	46
	Female thread (valveless)	10 704 5203	G 1"	-	91.5	53.1	46
	10 706 5203	G 1"	-	91.5	53.1	46	

Thread connections are listed according to ISO Standards. See Page 30 for additional information. All measurements are in mm. NBR=nitrile, FPM=Viton®. Check with an authorized CEJN distributor for availability and prices.



### Technical Data Series 706

Material: Stainless steel, AISI 316  
 Flow capacity at 4 bar pressure drop: 227 l/min (49.94 GPM UK)  
 Max. working pressure: 35 bar (508 PSI)  
 Min. burst pressure: 140 bar (2030 PSI)  
 Temperature range: FPM -15°C to +205°C (+5°F to +401°F)  
 Nominal flow diameter: 19.0 mm (3/4")  
 Kv (Cv): 6.81 (7.20)

# The Right Product for Each and Every Application

With unlimited combination possibilities, CEJN's non-drip modular couplings are adaptable to most applications and system requirements. This means customers will no longer be burdened with searching out application-worthy couplings. CEJN has already done the work for them by incorporating just what customers want and need most in a modular coupling line – versatility and virtually spillage-free performance.

The part number listing on Page 6 includes basic coupling and nipple combinations and reflects only a small portion of combinations that are possible by varying seals, threads, or other product features.

The fluid series includes both valved and valveless couplings and nipples, which further extend application possibilities. Valved styles are one-hand operated and are the most commonly used version in fluid system applications. Due to their construction, the valveless couplings require two hands for connection/disconnection and are useful in those applications in which fluid



With or without valve

loss upon disconnection may not be critical.

Three configurations are available in the extensive standard range:

- Single shutoff (must utilize a coupling and valveless nipple)
- Double shutoff
- Straight through

The series is compatible with working pressures up to 20 bar (290 PSI) and temperatures up to 275° C (527° F), making it suitable for a variety of low-pressure fluid applications in which lines need to be connected and disconnected easily, safely, and without spillage. Sizes available include body sizes from DN4 (5/32") to DN19 (3/4").

CEJN modular couplings are available in nickel-plated brass with nitrile seals and AISI 316 stainless steel with Viton® seals. EPDM and Kalrez® seals are available upon request to comply with specific performance objectives.

## Technical Data

Body Size	DN 4		DN 6		DN 9		DN 14		DN 19	
Series	267	277	467	477	567	577	667	677	767	777
<b>Materials</b>										
Nickel-plated brass	X		X		X		X		X	
Stainless steel AISI 316		X		X		X		X		X
<b>Flow Capacity</b>										
Double shutoff	17 l/min (3.7 GPM uk)		36 l/min (7.9 GPM uk)		76 l/min (16.7 GPM uk)		168 l/min (37.0 GPM uk)		306 l/min (67.3 GPM uk)	
Single shutoff	17 l/min (3.7 GPM uk)		36 l/min (7.9 GPM uk)		78 l/min (17.2 GPM uk)		193 l/min (42.5 GPM uk)		334 l/min (73.5 GPM uk)	
Straight through	32 l/min (7.0 GPM uk)		62 l/min (13.6 GPM uk)		187 l/min (41.1 GPM uk)		413 l/min (90.9 GPM uk)		803 l/min (176.7 GPM uk)	
<b>Max. Working Pressure</b>	20 bar (290 PSI)		20 bar (290 PSI)		20 bar (290 PSI)		20 bar (290 PSI)		20 bar (290 PSI)	
<b>Min. Burst Pressure</b>	80 bar (1160 PSI)		80 bar (1160 PSI)		80 bar (1160 PSI)		80 bar (1160 PSI)		80 bar (1160 PSI)	
<b>Nominal Flow Diameter</b>	4 mm (5/32")		6 mm (1/4")		9 mm (11/32")		14 mm (9/16")		19 mm (3/4")	
<b>Kv (Cv) (Double shutoff)</b>	0.51 (0.59)		1.08 (1.26)		2.28 (2.65)		5.04 (5.86)		9.18 (10.67)	
<b>Temperature Range</b>										
NBR (Nitrile rubber)	-15°C – +100°C (+5°F – +212°F)									
FPM (Viton®)	-5°C – +205°C (+23°F – +401°F)					Please note – Colored rings can only withstand heat up to +125°C (+257°F)				
EPDM	-20°C – +150°C (-4°F – +302°F)									
Kalrez®	-5°C – +275°C (+23°F – +527°F)					Please note – Colored rings can only withstand heat up to +125°C (+257°F)				

Flow capacity is measured at 4 bar pressure drop for all three versions. For more information about seal recommendations, conversion tables, maintenance advice, and other fluid products from CEJN, see the general CEJN Fluid Catalog, available at [www.cejn.com](http://www.cejn.com) or from your nearest authorized CEJN distributor. CEJN reserves the right to make changes without further notification. This right is applicable to all information in this brochure.

## Standard Range

Brass (NBR Seal)

Stainless Steel (FPM Seal)

Series 267	Description	Connection	Part No. G-thread	Part No. NPT-thread	Length (G)	Length (NPT)	Diameter	Hexagon
	Coupling, valveless	1/4" Female	10 267 0200	10 267 0400	43.5	59.2	23	19
Coupling, valved	1/4" Female	10 267 1200	10 267 1400	43.5	59.2	23	19	
Nipple, valveless	1/4" Female	10 267 5200	10 267 5400	48.5	48.5	20	19	
Nipple, valved	1/4" Female	10 267 6200	10 267 6400	48.5	48.5	20	19	

Series 467	Description	Connection	Part No. G-thread	Part No. NPT-thread	Length (G)	Length (NPT)	Diameter	Hexagon
	Coupling, valveless	3/8" Female	10 467 0200	10 467 0400	45.0	61.2	29	22
Coupling, valved	3/8" Female	10 467 1200	10 467 1400	45.0	61.2	29	22	
Nipple, valveless	3/8" Female	10 467 5200	10 467 5400	52.0	50.5	24	22	
Nipple, valved	3/8" Female	10 467 6200	10 467 6400	52.0	50.5	24	22	

Series 567	Description	Connection	Part No. G-thread	Part No. NPT-thread	Length (G)	Length (NPT)	Diameter	Hexagon
	Coupling, valveless	1/2" Female	10 567 0200	10 567 0400	52.5	68.2	34	27
Coupling, valved	1/2" Female	10 567 1200	10 567 1400	52.5	68.2	34	27	
Nipple, valveless	1/2" Female	10 567 5200	10 567 5400	56.5	55.0	29	27	
Nipple, valved	1/2" Female	10 567 6200	10 567 6400	56.5	55.0	29	27	

Series 667	Description	Connection	Part No. G-thread	Part No. NPT-thread	Length (G)	Length (NPT)	Diameter	Hexagon
	Coupling, valveless	3/4" Female	10 667 0200	10 667 0400	74.2	71.7	41	36
Coupling, valved	3/4" Female	10 667 1200	10 667 1400	74.2	71.7	41	36	
Nipple, valveless	3/4" Female	10 667 5200	10 667 5400	66.0	63.0	36	34	
Nipple, valved	3/4" Female	10 667 6200	10 667 6400	66.0	63.0	36	34	

Series 767	Description	Connection	Part No. G-thread	Part No. NPT-thread	Length (G)	Length (NPT)	Diameter	Hexagon
	Coupling, valveless	1" Female	10 767 0200	10 767 0400	82.0	79.0	52	46
Coupling, valved	1" Female	10 767 1200	10 767 1400	82.0	79.0	52	46	
Nipple, valveless	1" Female	10 767 5200	10 767 5400	67.5	64.5	44	41	
Nipple, valved	1" Female	10 767 6200	10 767 6400	67.5	64.5	44	41	

Series 277	Description	Connection	Part No. G-thread	Part No. NPT-thread	Length (G)	Length (NPT)	Diameter	Hexagon
	Coupling, valveless	1/4" Female	10 277 0210	10 277 0410	43.5	59.2	23	19
Coupling, valved	1/4" Female	10 277 1210	10 277 1410	43.5	59.2	23	19	
Nipple, valveless	1/4" Female	10 277 5210	10 277 5410	48.5	48.5	20	19	
Nipple, valved	1/4" Female	10 277 6210	10 277 6410	48.5	48.5	20	19	

Series 477	Description	Connection	Part No. G-thread	Part No. NPT-thread	Length (G)	Length (NPT)	Diameter	Hexagon
	Coupling, valveless	3/8" Female	10 477 0210	10 477 0410	45.0	61.2	29	22
Coupling, valved	3/8" Female	10 477 1210	10 477 1410	45.0	61.2	29	22	
Nipple, valveless	3/8" Female	10 477 5210	10 477 5410	52.0	50.5	24	22	
Nipple, valved	3/8" Female	10 477 6210	10 477 6410	52.0	50.5	24	22	

Series 577	Description	Connection	Part No. G-thread	Part No. NPT-thread	Length (G)	Length (NPT)	Diameter	Hexagon
	Coupling, valveless	1/2" Female	10 577 0210	10 577 0410	52.5	68.2	34	27
Coupling, valved	1/2" Female	10 577 1210	10 577 1410	52.5	68.2	34	27	
Nipple, valveless	1/2" Female	10 577 5210	10 577 5410	56.5	55.0	29	27	
Nipple, valved	1/2" Female	10 577 6210	10 577 6410	56.5	55.0	29	27	

Series 677	Description	Connection	Part No. G-thread	Part No. NPT-thread	Length (G)	Length (NPT)	Diameter	Hexagon
	Coupling, valveless	3/4" Female	10 677 0210	10 677 0410	74.2	71.7	41	36
Coupling, valved	3/4" Female	10 677 1210	10 677 1410	74.2	71.7	41	36	
Nipple, valveless	3/4" Female	10 677 5210	10 677 5410	66.0	63.0	39	36	
Nipple, valved	3/4" Female	10 677 6210	10 677 6410	66.0	63.0	39	36	

Series 777	Description	Connection	Part No. G-thread	Part No. NPT-thread	Length (G)	Length (NPT)	Diameter	Hexagon
	Coupling, valveless	1" Female	10 777 0210	10 777 0410	82.0	79.0	52	46
Coupling, valved	1" Female	10 777 1210	10 777 1410	82.0	79.0	52	46	
Nipple, valveless	1" Female	10 777 5210	10 777 5410	67.5	64.5	44	41	
Nipple, valved	1" Female	10 777 6210	10 777 6410	67.5	64.5	44	41	

All thread connections are listed according to ISO Standards. All measurements are in mm. Check with an authorized CEJN distributor for availability and prices.



# Stream-Line Straight Braided Hose For Water



CEJN Stream-Line straight polyurethane hose, designed for working pressures up to 10 bar, is suitable for both water and compressed air applications. When compressed air lines are in prolonged contact with water, use this hose instead of an air hose to ensure proper function.

Flexible and long lasting, it features two layers of blue ether-based PUR and a reinforced middle layer of polyester fiber. This construction gives the hose an extended temperature range of -30 °C to +60 °C. Additional sizes are available upon request.

Meter markings are indicated on the hose to make cutting and assembly easy.

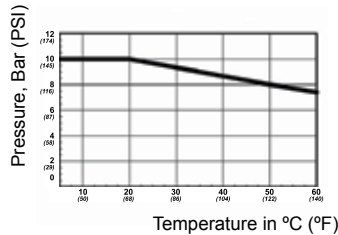

	Part No.	Size ID x OD (mm)	Working Pressure (bar/PSI)	Total Length per Roll (m)
Water	19 958 1240	8.0 x 12.0	10 / 145	100
	19 958 1640	11.0 x 16.0	10 / 145	100

## Stream-Line Hose Adapters For Series 321, Series 411 and with Standard Thread

	Hose ID x OD Dim. mm	Adapter Male Thread	R Thread with swivel	R Thread without swivel	NPT Thread with swivel	NPT Thread without swivel
Hose Fittings	8.0 x 12.0	1/4"	19 958 1262	19 958 1212	19 958 1292	19 958 1242
	8.0 x 12.0	3/8"	19 958 1264	19 958 1214	19 958 1294	19 958 1244
	11.0 x 16.0	1/2"	19 958 1665	19 958 1615	19 958 1695	19 958 1645
		Coupling 321	Nipple 321	Coupling 411	Nipple 411	
	8.0 x 12.0	10 321 1062	10 321 5062	-	-	
	11.0 x 16.0	10 321 1066	10 321 5066	10 411 1066	10 411 5066	

Thread connections are listed according to ISO Standards. See Page 30 for additional information. Check with an authorized CEJN distributor for availability and prices.

## Other CEJN Products Suitable for Fluid Applications

Other CEJN coupling series may be suitable for fluid applications, depending on working pressure and media. In addition, CEJN's range of breathing air couplings also includes the following brass styles:

- **Series 221** – Couplings with a "large-grip" locking sleeve that is interchangeable with Standard 221 nipples
- **Series 341, 344** – Single shutoff couplings and nipples with an integrated safety feature that protects against unintentional disconnection
- **Series 345, 347** – Double shutoff couplings and nipples with an integrated safety feature that protects against unintentional disconnection
- **Series 346** – Single or double shutoff couplings and nipples in AISI 316 stainless material with an integrated safety feature that protects against unintentional disconnection.

CEJN also offers stainless/chemical nickel-plated versions of Series 116 couplings in its high-pressure hydraulics range for extremely high pressures up to 1500 bar.

Brochures available on other CEJN products are listed on Page 31.

# Series 900

## Connectors, Adapters, Bushings, and Plugs

CEJN offers a wide range of hose connectors; male-to-male adapters; bushings; plugs; T-, L-, and Y-pieces; and crosses for compressed air and liquid applications. A wide range of both cylindrical and conical threads is available for maximum flexibility in a variety of applications. All adapters are plated for better protection against corrosion and feature a high burst pressure/working pressure factor of safety.

### Technical Data

Max. working pressure: 35 bar (507 PSI)  
Material: Plated brass



		Part No.	Connection
<b>Hose Tail Nipple</b>	Male/Hose	19 900 0211	R 1/8" - 3/16"
		19 900 0212	R 1/8" - 1/4"
		19 900 0221	R 1/4" - 3/16"
		19 900 0222	R 1/4" - 1/4"
		19 900 0223	R 1/4" - 5/16"
		19 900 0224	R 1/4" - 3/8"
		19 900 0225	R 1/4" - 1/2"
		19 900 0232	R 3/8" - 1/4"
		19 900 0233	R 3/8" - 5/16"
		19 900 0234	R 3/8" - 3/8"
		19 900 0235	R 3/8" - 1/2"
		19 900 0242	R 1/2" - 1/4"
		19 900 0243	R 1/2" - 5/16"
		19 900 0244	R 1/2" - 3/8"
		19 900 0245	R 1/2" - 1/2"
		19 900 0246	R 1/2" - 5/8"
		19 900 0247	R 1/2" - 3/4"
		19 900 0254	R 3/4" - 3/8"
		19 900 0255	R 3/4" - 1/2"
		19 900 0256	R 3/4" - 5/8"
19 900 0257	R 3/4" - 3/4"		
<b>Hose Menders</b>	Hose/Hose	19 900 0262	1/4" - 1/4"
		19 900 0264	3/8" - 3/8"
		19 900 0265	1/2" -
			1/2"
<b>Male Adapter</b>	Male/Male	19 900 1210	G 1/8" - G 1/8"
		19 900 1211	G 1/4" - G 1/8"
		19 900 1212	G 1/4" - G 1/4"
		19 900 1214	G 1/4" - G 3/8"
		19 900 1215	G 1/4" - G 1/2"
		19 900 1220	G 3/8" - G 1/8"
		19 900 1224	G 3/8" - G 3/8"
		19 900 1225	G 3/8" - G 1/2"
		19 900 1227	G 3/8" - G 3/4"
		19 900 1229	G 1/2" - G 3/4"
		19 900 1235	G 1/2" - G 1/2"
		19 900 1249	G 3/4" - G 3/4"
<b>Adapters</b>	Male/Female	19 900 2201	G 1/8" - G 1/8"
		19 900 2202	G 1/8" - G 1/4"
		19 900 2204	G 1/8" - G 3/8"
		19 900 2212	G 1/4" - G 1/4"
		19 900 2214	G 1/4" - G 3/8"
		19 900 2224	G 3/8" - G 3/8"
		19 900 2225	G 3/8" - G 1/2"
		19 900 2235	G 1/2" - G 1/2"
		19 900 2237	G 1/2" - G 3/4"

		Part No.	Connection
<b>Reducing Adap.</b>	Male/Female	19 900 3211	G 1/4" - G 1/8"
		19 900 3221	G 3/8" - G 1/8"
		19 900 3222	G 3/8" - G 1/4"
		19 900 3232	G 1/2" - G 1/4"
		19 900 3234	G 1/2" - G 3/8"
		19 900 3244	G 3/4" - G 3/8"
		19 900 3245	G 3/4" - G 1/2"
<b>Plug</b>	Male	19 900 4302	G 1/4"
		19 900 4304	G 3/8"
		19 900 4305	G 1/2"
		19 900 4307	G 3/4"
<b>T-piece</b>	Female/Female/Female	19 900 5302	G 1/4"
		19 900 5304	G 3/8"
		19 900 5305	G 1/2"
	Female/Male/Female	19 900 5309	G 1"
		19 900 5322	G 1/4"
		19 900 5324	G 3/8"
	Female/Female/Male	19 900 5325	G 1/2"
		19 900 5332	G 1/4"
		19 900 5334	G 3/8"
19 900 5335	G 1/2"		
<b>L-piece</b>	Male/Male	19 900 5361	G 1/8"
		19 900 5362	G 1/4"
		19 900 5364	G 3/8"
	Female/Female	19 900 5365	G 1/2"
		19 900 5371	G 1/8"
		19 900 5372	G 1/4"
	Male/Female	19 900 5374	G 3/8"
		19 900 5375	G 1/2"
		19 900 5379	G 1"
<b>Y-piece</b>	Female/Female/Female	19 900 5382	G 1/4"
		19 900 5384	G 3/8"
		19 900 5385	G 1/2"
	Female/Male/Female	19 900 5916	G 1/4"
		19 900 5912	G 3/8"
		19 900 5902	G 1/2"
<b>Cross</b>	Female/Female/Female/Female	19 900 5920	G 1/4"
		19 900 5921	G 3/8"
		19 900 5925	G 1/2"
	Male/Female/ Female/Male	19 900 5906	G 1/8"
		19 900 5905	G 1/4"
		19 900 5904	G 3/8"
		19 900 5903	G 1/2"
19 900 5932	G 1/4"		
19 900 5934	G 3/8"		
19 900 5935	G 1/2"		

Check with an authorized CEJN distributor for availability and prices.

# Thread Sealant



- Requires unnecessary time to apply thread tape or fluid.
- Danger of leakage if the tape or fluid isn't applied properly.
- Danger of loose tape or fluid getting onto the coupling or air system and causing problems.



- Ready to be attached
- Seals directly

### Series 321, 322, and 324

All couplings with male threads are pre-applied with thread sealant.

Pre-applied nipples available on request.

### CEJN Pre-applied Thread Sealant

CEJN's thread sealant is a dry, non-hardened product that seals against pressure immediately after assembly. The thread sealant does not lock the threaded components together, which makes the coupling/nipple easy to remove.

The sealant is gas- and water-approved in accordance with KTW, DVGW, ÖVGW, and SVGW. It is vibration resistant, water-based, and free of any organic solvents. Seals up to 150 bar. Max. temperature: 150° C.

# Flow Calculation

Kv= Flow in m<sup>3</sup>/hour @ ΔP=1 bar

Q= Flow (l/min)

Kv= Flow constant (m<sup>3</sup>/h)

ΔP= Pressure drop (bar)

$$Q = \frac{Kv \times 1000 \times \sqrt{\Delta P}}{60}$$

$$Kv = Cv \times 0.86$$

Recalculation of Pressure Drop or Water Flow Values  
Determine the pressure drop at 55 l/min for Series 321.

For Series 321, Kv=2.34

$$\Delta P = \left( \frac{Q \times 60}{Kv \times 1000} \right)^2$$

$$\Delta P = \left( \frac{55 \times 60}{2.34 \times 1000} \right)^2 = 1.99 \text{ bar}$$

With a Flowchart:

ΔP 3 bar gives a flow of 68 l/min.

What is the flow at ΔP 2 bar?

$$\frac{Q_1}{\sqrt{\Delta P_1}} = \frac{Q_2}{\sqrt{\Delta P_2}} \Rightarrow$$

$$Q_2 = \frac{Q_1 \times \sqrt{\Delta P_2}}{\sqrt{\Delta P_1}}$$

$$Q_2 = \frac{68 \times \sqrt{2}}{\sqrt{3}} = 55.5 \text{ l/min}$$

Cv=Flow in gallon/minute @ ΔP=1 PSI

Q= Flow (gallon/min)

Cv= Flow constant (gallon/min)

ΔP= Pressure drop (PSI)

$$Q = Cv \times \sqrt{\Delta P}$$

$$Cv = \frac{Kv}{0.86}$$

For Series 321, Cv=2.72

$$\Delta P = \left( \frac{Q}{Cv} \right)^2$$

$$\Delta P = \left( \frac{15}{2.72} \right)^2 = 30.4 \text{ PSI}$$

ΔP 20 PSI gives a flow of 12.16 GPM.

What is the flow at ΔP 40 PSI?

$$\frac{Q_1}{\sqrt{\Delta P_1}} = \frac{Q_2}{\sqrt{\Delta P_2}} \Rightarrow$$

$$Q_2 = \frac{Q_1 \times \sqrt{\Delta P_2}}{\sqrt{\Delta P_1}}$$

$$Q_2 = \frac{12.16 \times \sqrt{40}}{\sqrt{20}} = 17.2 \text{ GPM}$$



# Maintenance Tips

**To guarantee a coupling's function, quality and lifetime, be sure to:**

- Keep the coupling and nipple clean and dry. Dust and foreign matters may cause leakage.
- Avoid front-end impacts to the coupling and nipple.
- Check the sealing of the coupling and its moving parts regularly. If necessary, replace the coupling.
- Check the nipples on a regular basis. If they are heavily worn or marked, replace them. Worn nipples lead to greater wear on the couplings.
- Choose the proper connection for the application. Oversized connections cause unnecessary wear to the coupling.
- Avoid overtorquing when installing couplings and nipples.

# Technical Data

- Water flow:** ..... Measured within an accuracy of  $\pm 5\%$ . The unit used is "l/min" and stands for liter per minute.
- Sound level:** ..... Measured at a distance of 1 meter in front of and 1 meter beside a  $90^\circ$  angle in front of the object. The unit used is "dB (A)" and stands for decibel on the "A" scale.
- Working pressure:** ..... Specified in bar and PSI (pounds per square inch). Working pressure is often stipulated in varying national and international standards for quick-connect coupling.
- Burst pressure:** ..... Specified in bar and PSI and measured within an accuracy of  $\pm 2\%$ . Minimum burst pressure is calculated by multiplying the safety factor by the working pressure.
- Weight:** ..... Measured in "g" (gram) as an average of 10 pcs.
- Temperature range:** ..... Measured in Celsius degrees within an accuracy of  $\pm 2^\circ\text{C}$  ( $\pm 3.6^\circ\text{F}$ ).
- Kv and Cv value:** ..... See Page 26.
- Nominal flow diameter:** ..... Specifies the smallest flow area through the coupling and nipple.

All technical data are measured according to CEJN standards. Contact CEJN for more detailed information.

# Sealing Materials

MATERIALS	FEATURES	TEMPERATURE RANGE	MEDIA
<b>NBR</b> (Nitrile rubber Buna-N)	Resistant to water, gasoline, grease, mineral oil, heat, and alkalis. Sensitive to ozone.	-30°C to +100°C (-22°F to +212°F)	Compressed air, oil, water
<b>FPM</b> (Fluorocarbon rubber Viton®)	Recommended for gasoline, oils, and acids. Weather-resistant. Not recommended for hot steam.	-15°C to +200°C (-5°F to +392°F)	Chemicals, hot air
<b>EPDM</b> (Ethylene Propylene rubber EPDM/EPM)	Suitable for hot water, alkalines, and acids. Not recommended for mineral oil.	-40°C to +150°C (-40°F to +302°F)	Water
<b>Kalrez®</b>	Highly aggressive chemicals, pharmaceuticals, aerospace, and petroleum applications, oil and gas recovery, semiconductor wafer processing	+315°C (+600°F)	Chemicals oil, steam

Contact CEJN for more detailed information regarding sealing material and chemical compatibility with CEJN couplings.

# Units, Conversion Tables, and Formulas

## Pressure

FROM	TO	MULTIPLY BY	EXAMPLE
atm (atmosphere)	bar	1.01325	1.1 atm x 1.01325 = 1.115 bar
atm	MPa	0.10132	1.1 atm x 0.10132 = 0.111 MPa
atm	PSI	14.696	1.1 atm x 14.695 = 16.166 PSI
bar	atm	0.98692	10 bar x 0.98692 = 9.8692 atm
bar	MPa	0.1	10 bar x 0.1 = 1.0 MPa
bar	PSI	14.504	10 bar x 14.504 = 145 PSI
MPa (megapascal)	atm	9.8692	10 MPa x 9.8692 = 98.692 atm
MPa	bar	10	10 MPa x 10 = 100 bar
MPa	PSI	145.0	10 MPa x 145.0 = 1450 PSI
PSI (pounds / square inch)	atm	0.068	100 PSI x 0.068 = 6.80 atm
PSI	bar	0.0689	100 PSI x 0.0689 = 6.89 bar
PSI	MPa	0.00689	100 PSI x 0.00689 = 0.689 MPa

## Flow

FROM	TO	MULTIPLY BY	EXAMPLE
CFM (cubic feet / minute)	l/min	28.32	100 CFM x 28.32 = 2832 l/min
CFM	l/s	0.472	100 CFM x 0.472 = 47.2 l/s
CFM	m <sup>3</sup> /h	1.699	100 CFM x 1.699 = 169.9 m <sup>3</sup> /h
l/min (liter / minute)	CFM	0.0353	100 l/min x 0.0353 = 3.5 CFM
l/min	l/s	0.0167	100 l/min x 0.0167 = 1.7 l/s
l/min	m <sup>3</sup> /h	0.06	100 l/min x 0.06 = 6 m <sup>3</sup> /h
l/s (liter / second)	CFM	2.119	10 l/s x 2.119 = 21.2 CFM
l/s	l/min	60	10 l/s x 60 = 600 l/min
l/s	m <sup>3</sup> /h	3.6	10 l/s x 3.6 = 36 m <sup>3</sup> /h
m <sup>3</sup> /h (cubic meter / hour)	CFM	0.5885	10 m <sup>3</sup> /h x 0.5885 = 5.885 CFM
m <sup>3</sup> /h	l/min	16.667	10 m <sup>3</sup> /h x 16.667 = 166.7 l/min
m <sup>3</sup> /h	l/s	0.2777	10 m <sup>3</sup> /h x 0.2777 = 2.777 l/s

## Volume

FROM	TO	MULTIPLY BY	EXAMPLE
ft <sup>3</sup> (cubic foot)	gl UK	6.228	10 ft <sup>3</sup> x 6.228 = 62.28 gl UK
ft <sup>3</sup>	gl U.S.	7.48	10 ft <sup>3</sup> x 7.48 = 74.8 gl U.S.
ft <sup>3</sup>	l	28.32	10 ft <sup>3</sup> x 28.32 = 283.2 l
ft <sup>3</sup>	m <sup>3</sup>	0.0283	10 ft <sup>3</sup> x 0.0283 = 0.283 m <sup>3</sup>
gl UK (gallon UK)	ft <sup>3</sup>	0.1605	10 gl UK x 0.1605 = 1.605 ft <sup>3</sup>
gl UK	gl U.S.	1.2009	10 gl UK x 1.2009 = 12.009 gl U.S.
gl UK	l	4.546	10 gl UK x 4.546 = 45.46 l
gl UK	m <sup>3</sup>	0.0045	10 gl UK x 0.0045 = 0.045 m <sup>3</sup>
gl U.S. (gallon U.S.)	ft <sup>3</sup>	0.1336	10 gl U.S. x 0.1336 = 1.336 ft <sup>3</sup>
gl U.S.	gl UK	0.8326	10 gl U.S. x 0.8326 = 8.326 gl UK
gl U.S.	l	3.785	10 gl U.S. x 3.785 = 37.85 l
gl U.S.	m <sup>3</sup>	0.0037	10 gl U.S. x 0.0037 = 0.037 m <sup>3</sup>
l (liter)	ft <sup>3</sup>	0.0353	100 l x 0.0353 = 3.53 ft <sup>3</sup>
l	gl UK	0.220	100 l x 0.220 = 22.0 gl UK
l	gl U.S.	0.264	100 l x 0.264 = 26.4 gl U.S.
l	m <sup>3</sup>	0.001	100 l x 0.001 = 0.1 m <sup>3</sup>
m <sup>3</sup> (cubic meter)	ft <sup>3</sup>	35.3	10 m <sup>3</sup> x 35.3 = 353 ft <sup>3</sup>
m <sup>3</sup>	gl UK	219.96	10 m <sup>3</sup> x 219.96 = 2199.6 gl UK
m <sup>3</sup>	gl U.S.	264.17	10 m <sup>3</sup> x 264.17 = 2641.7 gl U.S.
m <sup>3</sup>	l	1000	10 m <sup>3</sup> x 1000 = 10 000 l

## Force

FROM	TO	MULTIPLY BY	EXAMPLE
lbf (pound force)	kp	0.454	10 lbf x 0.454 = 4.54 kp
lbf	N	4.448	10 lbf x 4.448 = 44.48 N
kp (kilogram force)	lbf	2.205	10 kp x 2.205 = 22.05 lbf
kp	N	9.806	10 kp x 9.806 = 98.06 N
N (newton)	lbf	0.2248	10 N x 0.2248 = 2.25 lbf
N	kp	0.1020	10 N x 0.1020 = 1.02 kp

## Length

FROM	TO	MULTIPLY BY	EXAMPLE
ft (foot)	inch	12	10 ft x 12 = 120 inch
ft	m	0.3048	10 ft x 0.3048 = 3.048 m
ft	mm	304.8	10 ft x 304.8 = 3048 mm
inch	ft	0.0833	10 inch x 0.0833 = 0.833 ft
inch	m	0.0254	10 inch x 0.0254 = 0.254 m
inch	mm	25.4	10 inch x 25.4 = 254 mm
m (meter)	ft	3.28083	10 m x 3.28083 = 32.8083 ft
m	inch	39.3699	10 m x 39.3699 = 393.699 inch
m	mm	1000	10 m x 1000 = 10 000 mm
mm (millimeter)	ft	0.00328	10 mm x 0.00328 = 0.0328 ft
mm	inch	0.0393	10 mm x 0.0393 = 0.393 inch
mm	m	0.001	10 mm x 0.001 = 0.01 m

## Mass

FROM	TO	MULTIPLY BY	EXAMPLE
g (gram)	kg	0.001	10 g x 0.001 = 0.01 kg
g	lb	0.0022	10 g x 0.0022 = 0.022 lb
g	oz	0.0352	10 g x 0.0352 = 0.352 oz
kg (kilogram)	g	1000	10 kg x 1000 = 10 000 g
kg	lb	2.205	10 kg x 2.205 = 22.05 lb
kg	oz	35.273	10 kg x 35.273 = 352.73 oz
lb (pound)	g	453.9	10 lb x 453.9 = 4539 g
lb	kg	0.4539	10 lb x 0.4539 = 4.539 kg
lb	oz	16	10 lb x 16 = 160 oz
oz (ounce)	g	28.349	10 oz x 28.349 = 283.49 g
oz	kg	0.0283	10 oz x 0.0283 = 0.283 kg
oz	lb	0.0625	10 oz x 0.0625 = 0.625 lb

## Torque

FROM	TO	MULTIPLY BY	EXAMPLE
kpm (kilo pound meter)	lbfft	7.233	10 kpm x 7.233 = 72.33 lbfft
kpm	Nm	9.81	10 kpm x 9.81 = 98.1 Nm
lbfft (pound force foot)	Nm	1.356	10 lbfft x 1.356 = 13.56 Nm
lbfft	Nm	0.1383	10 lbfft x 0.1383 = 1.38 kpm
Nm (newton meter)	kpm	0.1020	10 Nm x 0.1020 = 1.02 kpm
Nm	lbfft	0.7376	10 Nm x 0.7376 = 7.38 lbfft

# Equivalent Chart for Hose and Hose Fittings

## Hose Size

Inner Dia. x Outer Dia. in mm	Inner Dia. x Outer Dia. in inch	U.S. Nominal
5 x 8	0.196 x 0.314	3/16" (0.1875 inch)
6.5 x 10	0.255 x 0.393	1/4" (0.250 inch)
8 x 12	0.314 x 0.472	5/16" (0.3125 inch)
9.5 x 13.5	0.374 x 0.531	3/8" (0.375 inch)
11 x 16	0.433 x 0.630	7/16" (0.4375 inch)

## Hose Connection Size

Connection Size in mm	Connection Size in inch	U.S. Nominal
6.3	0.248	1/4" (0.250 inch)
10	0.393	3/8" (0.375 inch)
13	0.512	1/2" (0.5 inch)
16	0.630	5/8" (0.625 inch)
19	0.748	3/4" (0.75 inch)

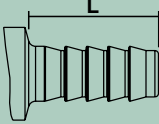
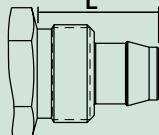
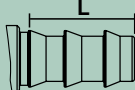
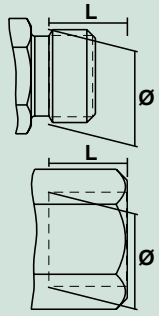
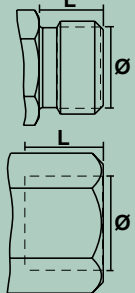
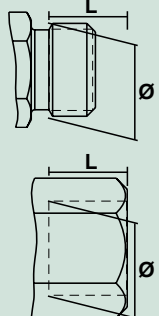

# Connections and Thread Standards

		Connection	Ø (mm)	L (mm)
<b>Hose Connection</b> Standard hose barb for hose clamp		6.3 mm (1/4")	-	18.0
		8 mm (5/16")	-	18.0
		10 mm (3/8")	-	21.0
		13 mm (1/2")	-	21.0
		16 mm (5/8")	-	23.0
<b>Stream-Line Connection</b> Hose barb with nut cap for reusable and safe hose clamping		5 x 8 mm	-	15.0
		6.5 x 10 mm	-	17.0
		8 x 12 mm	-	19.0
		9.5 x 13.5 mm	-	21.0
		11 x 16 mm	-	25.0
<b>CEJN-Lock Connection</b> For special non-clamping hose		1/4"	-	19.0
		3/8"	-	23.0
		1/2"	-	26.0
<b>R/Rc Thread Connection</b> Conical Pipe Thread Connection According to ISO 7/1 (Other common descriptions are BSPT, Kr)  <i>Male: ie. R 1/4"</i> <i>Female: ie. Rp 1/4" (parallel)</i> <i>ie. Rc 1/4" (taper)</i>		<b>Male Thread</b>		
		R 1/8"	10.2	7.4
		R 1/4"	13.6	11.0
		R 3/8"	17.2	11.0
		R 1/2"	21.7	15.0
		R 3/4"	27.1	16.3
		<b>Female Thread</b>		
		Rc 1/8"	8.3	7.4
		Rc 1/4"	11.0	11.0
		Rc 3/8"	14.5	11.4
Rc 1/2"	18.0	15.0		
Rc 3/4"	23.5	16.3		
<b>G Thread Connection</b> Cylindrical Pipe Thread Connection According to ISO 228/1 (Other common descriptions are BSP, R)  <i>Male: ie. G 1/4"</i> <i>Female (ISO 1179): ie. G 1/4"</i>		<b>Male Thread</b>		
		G 1/8"	9.6	8.0
		G 1/4"	13.0	10.0
		G 3/8"	16.5	10.0
		G 1/2"	20.8	12.0
		G 3/4"	26.3	12.0
		<b>Female Thread</b>		
		G 1/8"	8.75	7.4
		G 1/4"	11.8	11.0
		G 3/8"	15.25	11.4
G 1/2"	19.0	15.0		
G 3/4"	24.5	16.3		
<b>NPT Thread Connection</b> National Pipe Thread American standard according to ANSI/ASME B 1.20.1  <i>Male and female: ie. 1/4" NPT</i>		<b>Male Thread</b>		
		NPT 1/8"	10.5	6.7
		NPT 1/4"	14.0	10.2
		NPT 3/8"	17.5	10.4
		NPT 1/2"	21.8	13.6
		NPT 3/4"	27.1	13.9
		<b>Female Thread</b>		
		NPT 1/8"	8.5	6.9
		NPT 1/4"	11.0	10.0
		NPT 3/8"	14.5	10.3
NPT 1/2"	18.0	13.6		
NPT 3/4"	23.0	14.1		

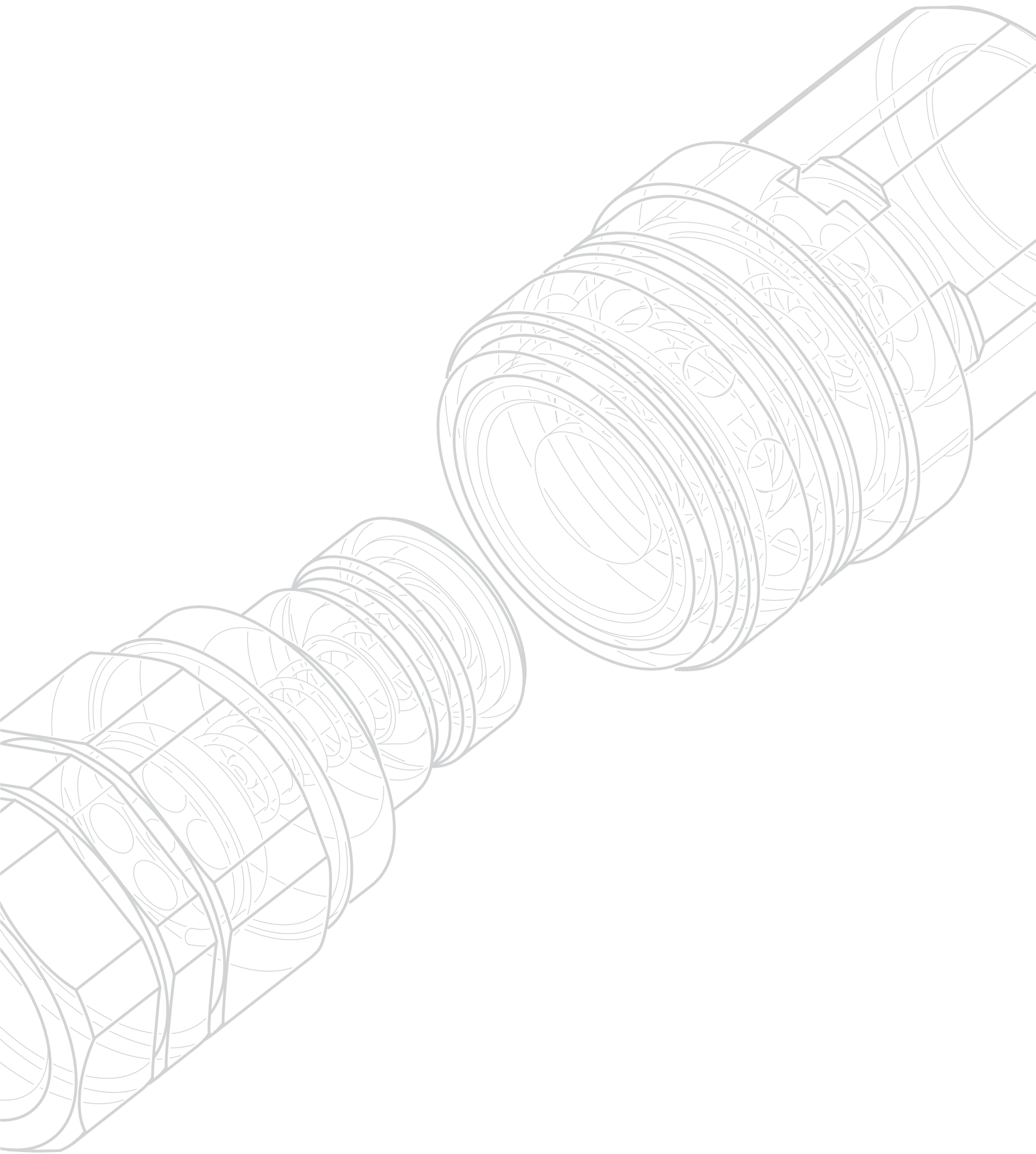

## **Other Products Available from CEJN**

*To obtain product information or product brochures, contact your nearest CEJN office or representative, or visit us on the Internet at [www.cejn.com](http://www.cejn.com)*

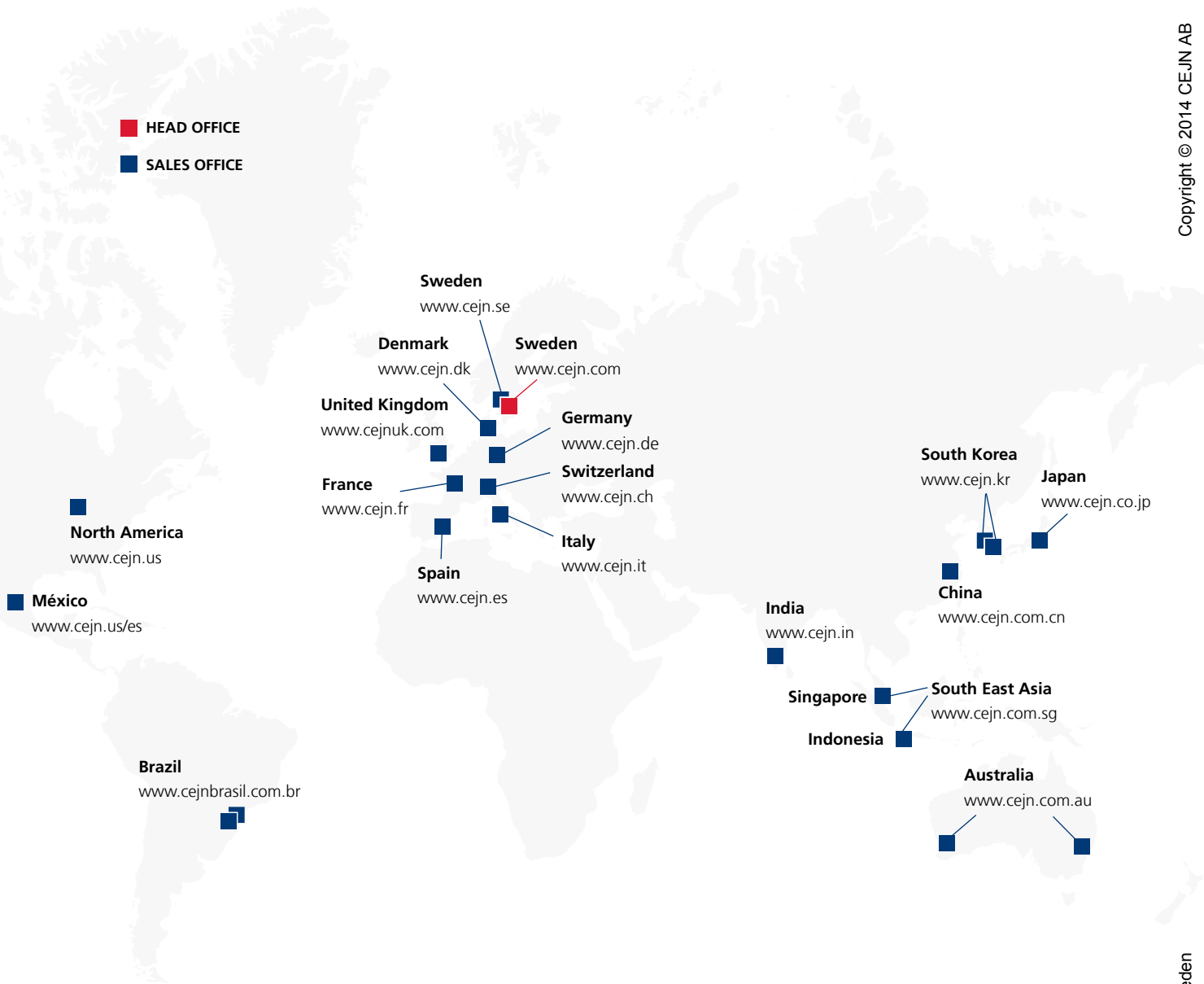

**CEJN**® *The Quick Connect*  
**Solution Provider**

