

Engineering Solutions

- Using Quick Connect Technology

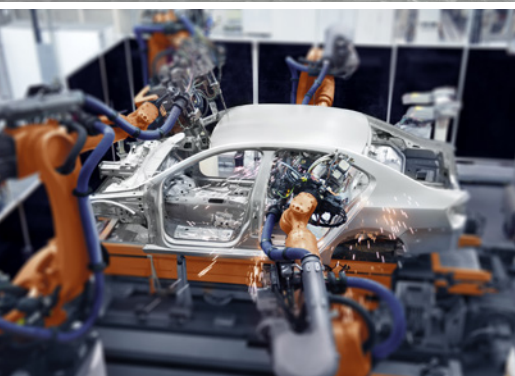
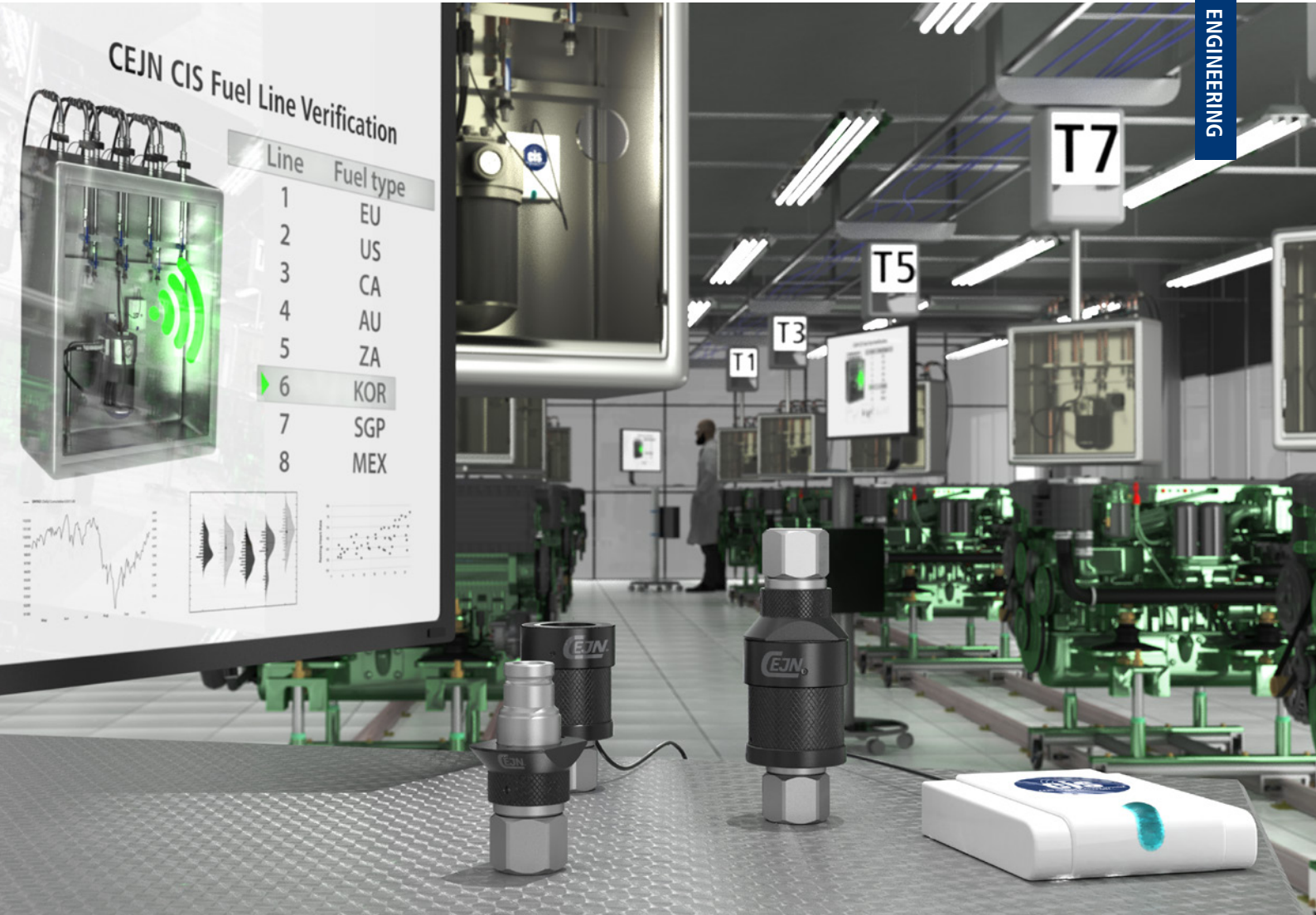

CLOSE TO YOUR BUSINESS, FAST TO RESPOND

Close cooperation is essential for a successful project. Each Engineering solution is unique and it is a collaboration between the customer, application expert and design engineer. CEJN's skilled application experts translate customer needs into viable product solutions, while the design engineer is responsible for custom-made prototypes, small batch runs and special materials.

The vision is transformed into a physical product at our first-class production facility, followed by stringent testing in the laboratory before it is delivered to you. CEJN's wide range of standard quick connect products together with 60 years of experience as a company specialized in quick couplings, provide you with invaluable resources – all under one roof.

Following initial contact we will put you in touch with our Engineering department at one of our Design Centers. Your project will have a designated Design Engineer and Application Expert who will work closely with you throughout the development process: from idea to finished product.





CUSTOM-MADE QUICK COUPLINGS FOR ANY APPLICATION

CEJN's standard range of quick connect couplings, consist of more than 8000 items. Still, there are many cases where the quick connect solutions need to be customized to fit the application.

Our experts can adapt quick couplings to fit your applications with the usual benefits that quick couplings provide for a system: ease of use, reliability, safety and performance. Non-drip couplings offer the advantages of spill-free connection and disconnection and ability to connect while there still is pressure in the system. With a special engineered solution, you will get a quick coupling solution that is perfectly adapted for your application.

Each project is unique and with our experience and production capacity, we can help you invent a solution that is just right for your needs. Sometimes, it is a completely new product but more often, it is a variant of existing products. Most projects can be divided into different types: Single couplings, hand-operated multi-connectors or auto-dock solutions.

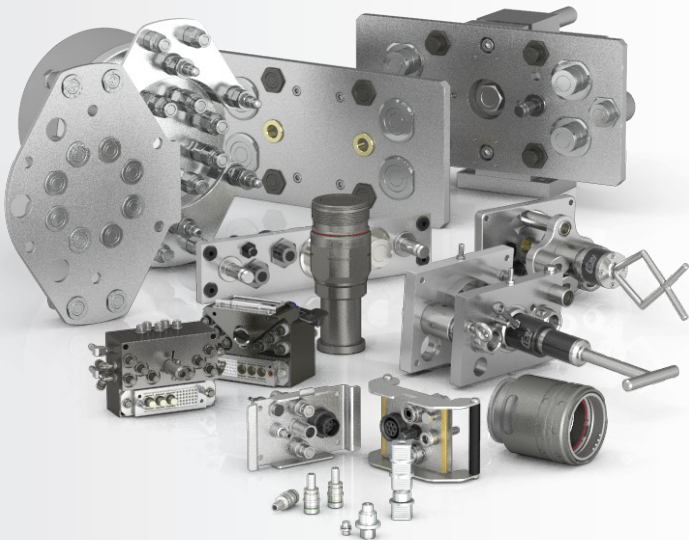

COUPLING BRACKET
Produced using rapid prototype
technology for small batch
production



Stainless steel flat-face
coupling for robot handling



Non-drip coupling
with built-in swivel



Miniature high pressure coupling
for product test



Test coupling for tube end



DN 3 AUTO-COUPLING
CEJN's smallest coupling for
electronic cooling



Special connection on 2" TLX



3" Engine test coupling
"turbo inlet"



SINGLE COUPLINGS

Single couplings are generally based on CEJN's standard range of products but they can be adapted to fit any type of port, stem or pipe in any dimension. A variety of surface treatments and forms are also common customizations for an engineering project. Single coupling solutions are perfect when there are few lines to connect and the demand for versatility is greater than the risks of making the wrong connections.



ELECTRONIC VERIFICATION WITH CEJN CIS

Couplings can also be integrated with special features like NFC (Near-Field Communication) technology for reliable verification of which coupling is connected to which nipple. For example, this can be useful in engine testing applications when engines are tested with different fuel qualities.

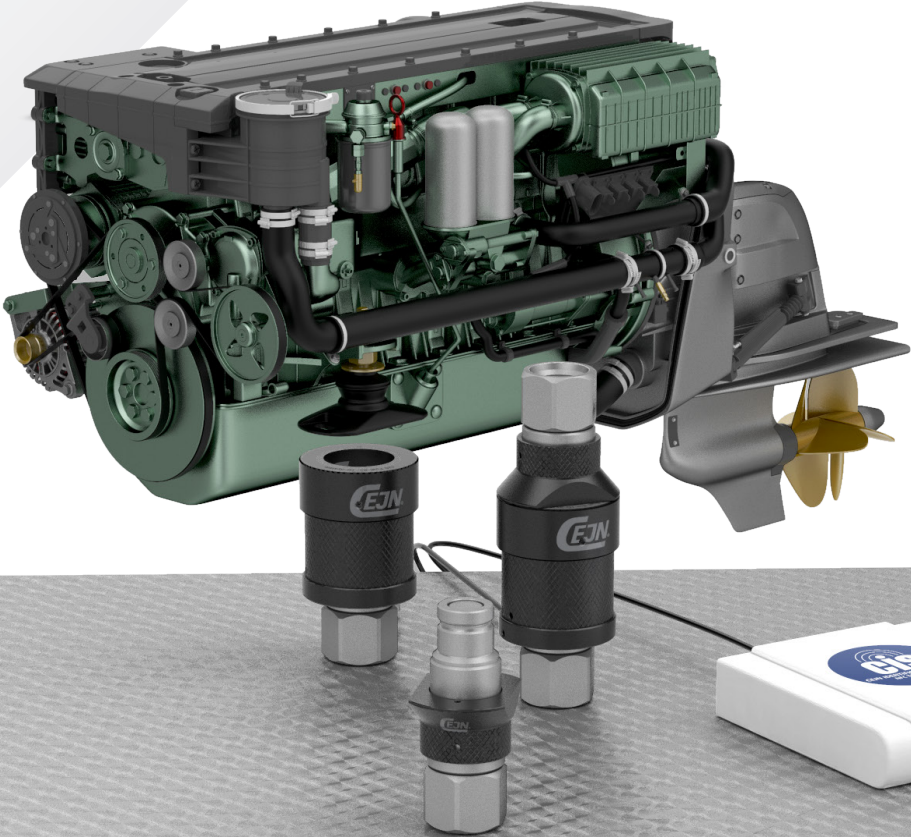

P8 MULTI-COUPLING
Multi-Coupling used to connect hot water, compressed air and electricity supply to parked vehicles



SPECIAL MULTI-X
A special Multi-X version for a welding application. Custom made hand operated multi connector with 4 lines of fluid couplings and 4 lines of pneumatics and electrical connectors for signal and power

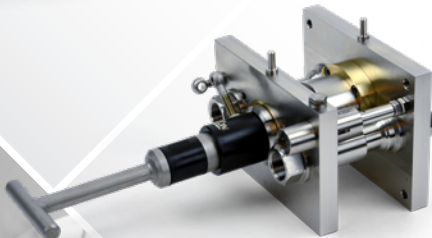

MQC STAB PLATE
Multiple Quick Connect STAB plate



MULTI-X QUATTRO
A Multi-X in aluminium and stainless steel (AISI 316) for offshore and industrial applications

HAND OPERATED MULTI-CONNECTORS

Multi-plate couplings are perfect when there are several lines to connect with the same or different types of media. A multi-plate can combine both hydraulic, pneumatic, fluid, gas and/or electrical connections into one, eliminating any risks of cross connections.

The multi-plate is connected and secured with a lever. Guiding pins make sure that the coupling is properly aligned. The layout, dimension and materials can be completely customized to fit perfectly into your application.

The manual operation makes it especially suitable when there are less frequent connections and disconnections and any risks of cross connections must be eliminated.

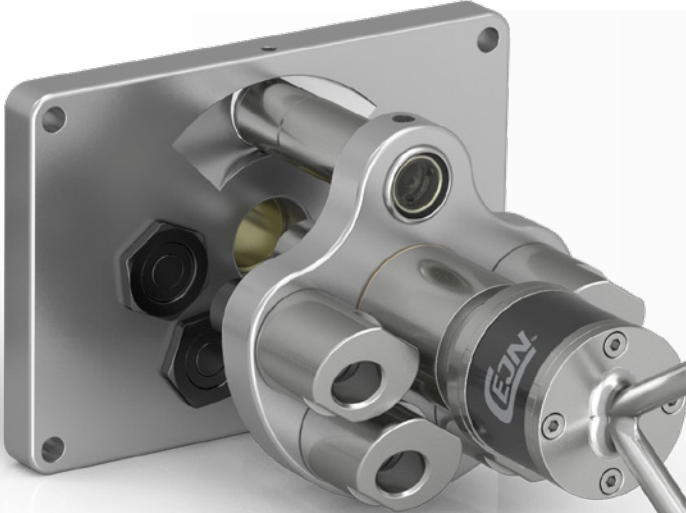

SUBSEA MULTI-QUICK CONNECTOR (SSMQC)
An ROV (Remote Operated Vehicle) optimized multi-connector for deepsea operation



AUTO-DOCK SOLUTIONS

Auto-dock solutions offer the unique advantage to connect and disconnect under full working pressure. Special engineered auto-dock solutions are often used in automated industrial environments or where human access is limited for manual operation. As with the hand-operated multi-plates, the auto-couplings can combine several media and electrical connections into one single connection. External pressure secures the connection.

Auto-couplings are especially suitable when there are frequent connections and disconnections. They can even be installed on a pallet production line for industrial automation.



AUTO-COUPLING MANIFOLD
Stainless steel manifold of quick connect couplings with an integrated filter for cooling of welding robots



AUTOMATIC DOCKING PLATE
for cold test of a car engine, two fuel lines and electrical contact for signals

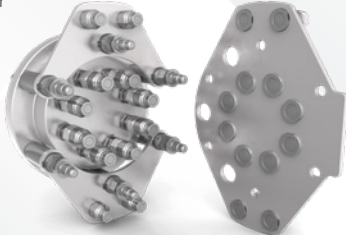

MULTI-COUPLING FOR PAPER MACHINES
Manual plate to connect 8 x Series 665 and 4 x Series 565. The couplings are made of stainless steel



HYDRAULIC MULTI-PLATE
Big hydraulic multi-plate for industrial automation



- HEAD OFFICE
- SALES OFFICE
- DESIGN CENTERS



Made in Sweden since 1955

We have been producing professional, high-quality and innovative quick connect couplings here at CEJN since our first patented coupling was launched in 1955. CEJN is an independent global niche company with its head office in the heart of Sweden. Over the years we have expanded to 22 locations, offering three Design Centers worldwide and supplying products and services to virtually every industry segment. At CEJN, we are united by our five core values: safety, environment, quality, innovation and performance. They are our cornerstones and define who we are, how we work, what we believe in and what we stand for.

Contact your local sales office or www.cejn.com for more information.